

RTX-4M3V-FSK is an RF digital data transceiver working on the ISM free-license band of 433.92 MHz, in half-duplex way, ASK modulated and fast switch time TX→RX and RX→TX.

It's ideal for low cost solutions, battery supplied systems and thanks to its small size to hand held terminals.

Max speed rate is 4 Kbit/sec Manchester encoded.

The device can work in compliance with HCS Microchip data frame.

All transceiver features can be handled by 4 lines (RX/TX, ENABLE, DATA IN, DATA OUT).

The module is available at 3V of power supply and it's compliant to EN300 220 and EN301 489 rules.

Characteristics

- **Low current consumption**
- **Low cost**
- **PLL synthesis crystal based**
- **Single RF channel**
- **Very small size (25.4x12.43 mm)**
- **Max bit rate : 4800 bps**
- **Max Output Power : 10 mW**
- **High sensitivity on reception**
- **Voltage supply: 3V or 5V**

Applications

- **Wireless handsfree devices**
- **Home automation**
- **Wireless sensors**
- **Meter reading**
- **2-way remote controls**
- **Data logging**

Absolute maximum

Operational Temperature	-20 °C ÷ +85 °C
Stocking Temperature	-40 °C ÷ +100 °C
Voltage Supply	-0,3V ÷ +6V
Input Voltage	-0,3V ÷ VCC+0,3V
Output Voltage	-0,3V ÷ VCC+0,3V

Le caratteristiche tecniche possono subire variazioni senza preavviso. AUR°EL S.p.A. non si assume la responsabilità di danni causati dall'uso improprio del dispositivo.

Technical Characteristics

Table 1 – Technical characteristics

	Min.	Typ.	Max.	Unit
DC Levels				
Voltage supply	2.5	3	3.6	V
Supply current (Rx mode) Enable=1 TX/RX=0		10.4		mA
Supply current(PWRDWN mode) Enable = 0 TX/RX = 0 Data in = 0		0.5		µA
Supply current (Tx mode) Enable = 1 TX/RX = 1		18.6		mA
Logic level "1" in input/output	0,9 X Vcc			V
Logic level "0" in input/output			0,1 X Vcc	V
ESD antenna protection (contact)		±4		kV
ESD antenna protection (discharge)		±8		kV
Receiver				
Frequency		433.92		MHz
Modulation	FSK			
RX sensitivity RF generator with FM $\Delta f = 31\text{KHz}$ Data in = square wave 1KHz		-103		dBm
Image frequency		433.072		MHz
Image frequency sensitivity		-57		dBm
Intermediate frequency (IF)		400		kHz
Intermediate frequency band -3dB		230		KHz
RF band (SAW filtered)		720		KHz
Data rate			9.6	Kbps
Transmitter				
Transmission frequency		433,92		MHz
Modulation	FSK			
RF output power		7.5		dBm
Spurious emission <1GHz			-44	dBm
Spurious emission from 1GHz to 4GHz			-55	dBm
Data-rate			4.8	Kbps

Le caratteristiche tecniche possono subire variazioni senza preavviso. AUR°EL S.p.A. non si assume la responsabilità di danni causati dall'uso improprio del dispositivo.

Switching times				
PWRDN → RX				
Sensitivity -91dBm		4		ms
Sensitivity -102dBm		6		
PWRDN → TX		5		ms
TX → RX				
Sensitivity -91dBm		1.5		ms
Sensitivity -102dBm		2		
RX → TX		100		µs

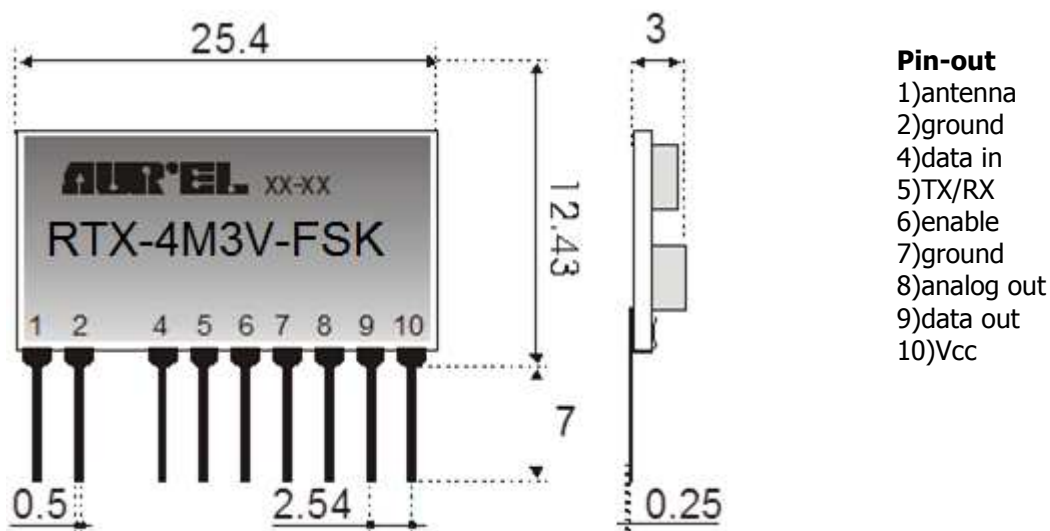
Pin description and mechanical size

Table 2 – Pin description

n° Pin	Name	Description
1	Antenna	Antenna connection 50 ohm. RF output for TX, RF input for RX
2	GND	Ground
4	Data In	Data Input of TX 1 = emission of carrier 0 = no emission
5	TX/RX	0 or floating = Receiver mode (Receiver ON, Transmitter OFF) 1 = Transmitter (Receiver OFF, Transmitter ON) NOTE: look at figure 2 for switching times Pin connected to pull down resistor
6	Enable	Enable = 0 : PWRDWN Enable = 1 : Device ON
7	GND	Ground

Le caratteristiche tecniche possono subire variazioni senza preavviso. AUR^oEL S.p.A. non si assume la responsabilità di danni causati dall'uso improprio del dispositivo.

8	Analog Out	Output analog for test purpose. RSSI analog value of the received signal power. Refer to Figure 14.
9	Data Out	Digital data output of receiver with 0-Vcc voltage range. When in transmission (pin 5 high) data output is logic level low.
10	Vcc	Connection to the supply positive pole: Connect 100 nF capacitor towards ground plane

Block diagram

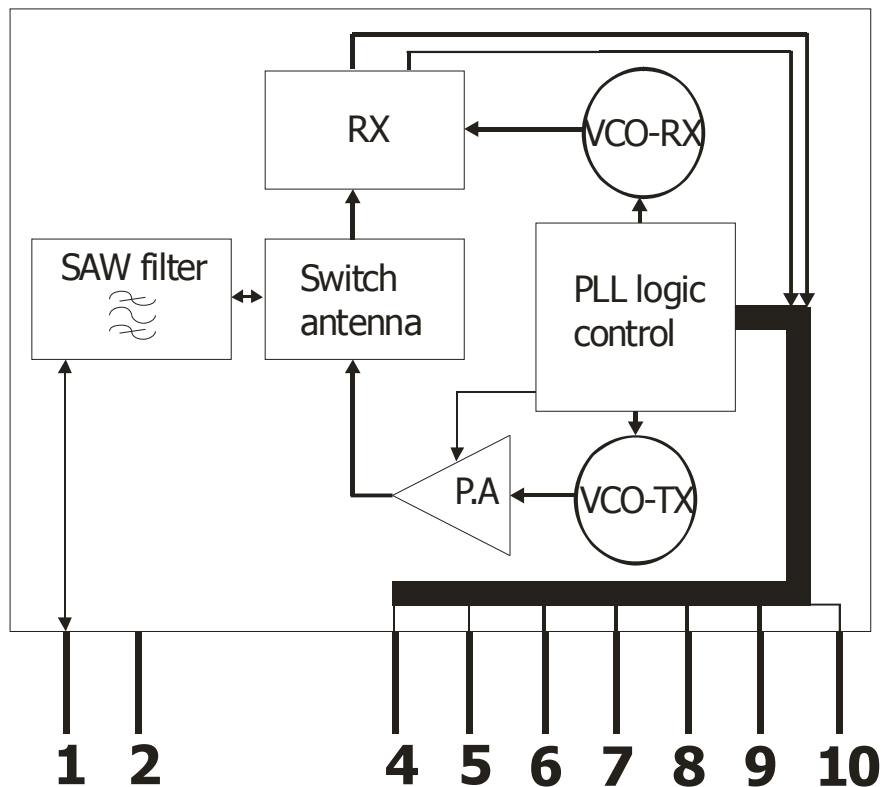

Figure 1

Transmitter

It embeds a VCO oscillator controlled by PLL circuit in order to achieve short switching time TX-RX and wake up time from stand-by mode.

A power amplifier boosts the emitted power up to 7.5dBm.

Spurious emissions are limited by SAW filter technology.

Transmitter is switched on driving high RX/TX line and low the data in line.

The PLL circuit switches on in 200-300 μ S, necessary time to set properly the RF oscillator.

In order to transmit, drive high or low the data in line according to the desired data sequence.

Le caratteristiche tecniche possono subire variazioni senza preavviso. AUR°EL S.p.A. non si assume la responsabilità di danni causati dall'uso improprio del dispositivo.

Data can be an encoded frame or just coming from data out port. The data rate must be lower than 10 kbit/sec.

Receiver

It's a single conversion superhet receiver with local oscillator, mixer circuit with frequency image rejection and IF frequency at 400 kHz.

Front end circuit and AGC:

A SAW filter is in the middle between antenna and pre-amplifier stage. AGC (automatic gain control) circuit acting on the gain improves the dynamic of RF received signal.

AGC turns on whenever the RF received signal is more powerful than -74dBm and it sets the max gain 7ms after the RF signal goes down the -59 dBm.

This tolerance range prevents endless switches of AGC during reception.

Data-Slicer:

This circuit converts the analog signal coming from L.F. to digital one.

It's made up of a comparator, analog signal is connected to RC network with charge and discharge (time constant equals to 2.25ms).

The circuit allows reception of data pulses with length lower than 5 ms and higher than 100 us.

It's not possible to receive UART RS-232 signals. It's highly suggested to use a balanced code (Manchester) as the byte contains at least a high or low level, allowing the peak detector to operate properly.

It's not possible to receive a DC low or high level for a time longer than 10ms; therefore in case of receiving proprietary data frame, it is recommended to encode data taking care of the pulse length limit (10ms).

Squelch immunity to data output:

The digital output of receiver (pin 9) is not immune to white noise generated by the receiver itself when no carrier is on air, then pseudo-random code, like white noise, comes out of the data output.

Typically digital output is connected to the input port of a microcontroller which must recognize valid data among the white noise.

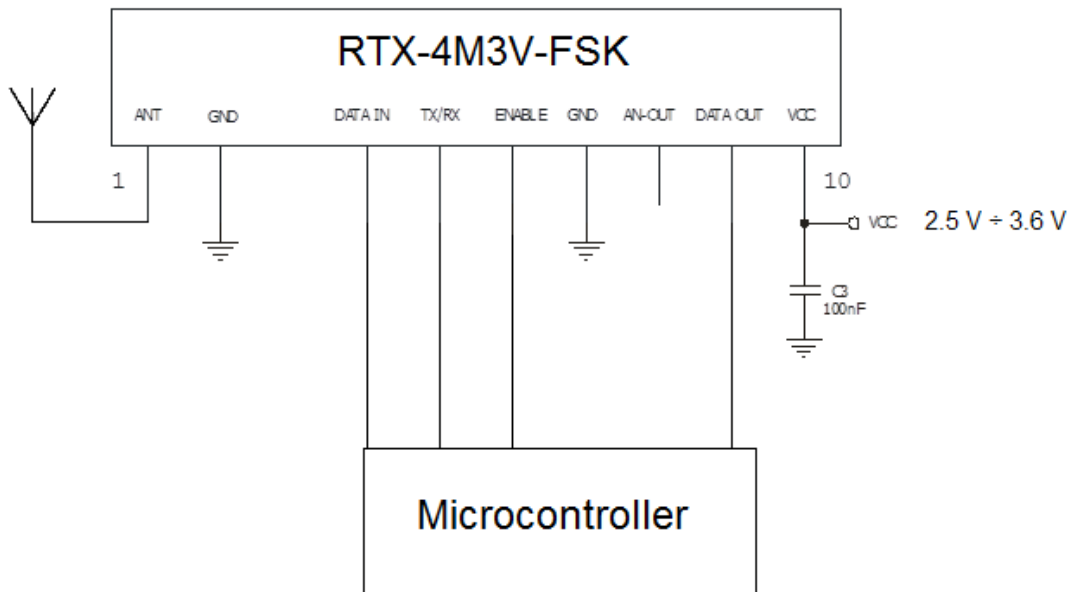
Figure 2

Operational modes

RTX-MID can work in 4 different modes:

- 1. Power Down Mode**
- 2. Idle Mode**
- 3. RF Transmission Mode**
- 4. RF Receiving Mode**

1. Power Down Mode

By driving low level pin 6 (ENABLE) the device enters the saving-energy mode, where consumption is less than 1 μ A: this mode the transceiver can't neither receive nor transmit.

2. Idle Mode

Initial state where the transceiver is in idle mode when pin 6 (ENABLE) and pin 5 (TX/RX) are high and pin 4 (data in) is low level.

In idle mode the transceiver is on with consumption of 19 mA.
PLL circuit of transmitter is active.

Le caratteristiche tecniche possono subire variazioni senza preavviso. AUR°EL S.p.A. non si assume la responsabilità di danni causati dall'uso improprio del dispositivo.

3. RF Transmission Mode

When the pin 5 (TX/RX) and 6 (ENABLE) are both high, the RF carrier is emitted through antenna with 7.5 dBm power and the overall consumption is around 19 mA.

4. RF Receiving Mode

Receiving mode is selected by driving low pin 5 (RX/TX) and high pin 6 (ENABLE).

Switching PWRDN→RX, PWRDN→TX, RX→TX, TX→RX.

In order to respect latency time of PLL circuit and peak detectors in data-slicer stage, it is mandatory to keep the timing in the following pictures, in switching from TX to RX, from RX to TX and from power down to RX or TX.

Time chart PWRDN→RX

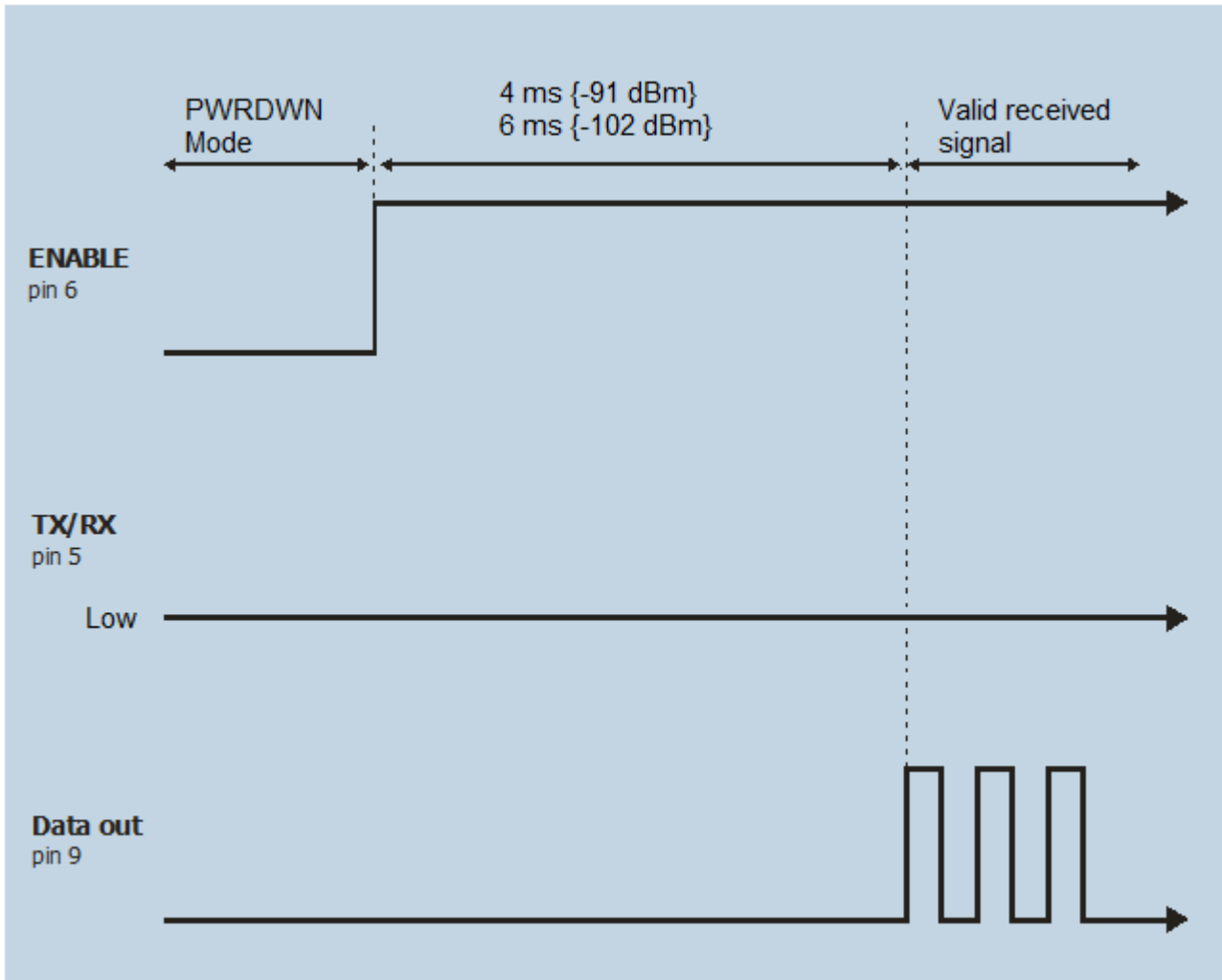

Figure 3

Time chart PWRDWN→ TX

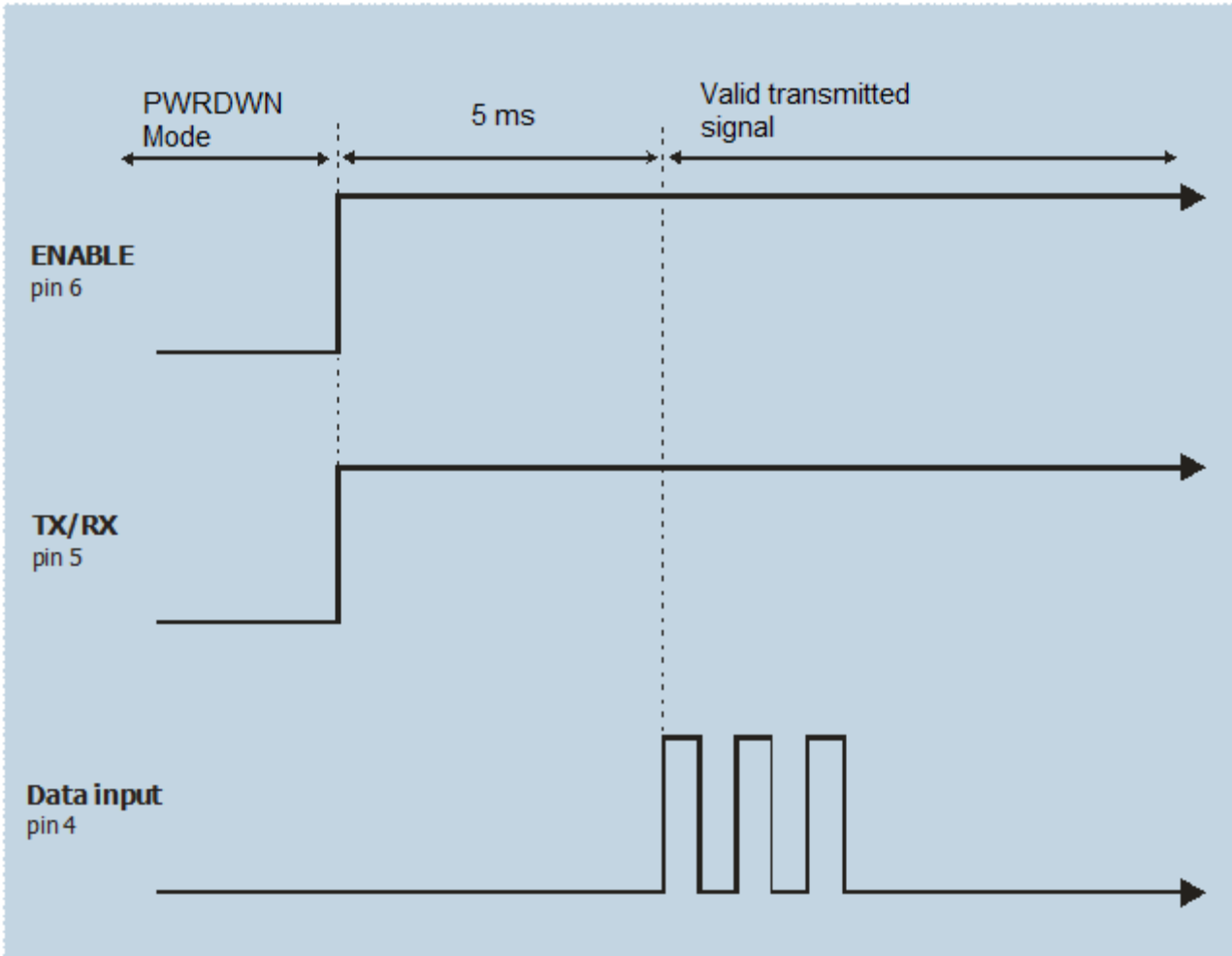

Figure 4

Le caratteristiche tecniche possono subire variazioni senza preavviso. AUR°EL S.p.A. non si assume la responsabilità di danni causati dall'uso improprio del dispositivo.

Time chart RX→ TX

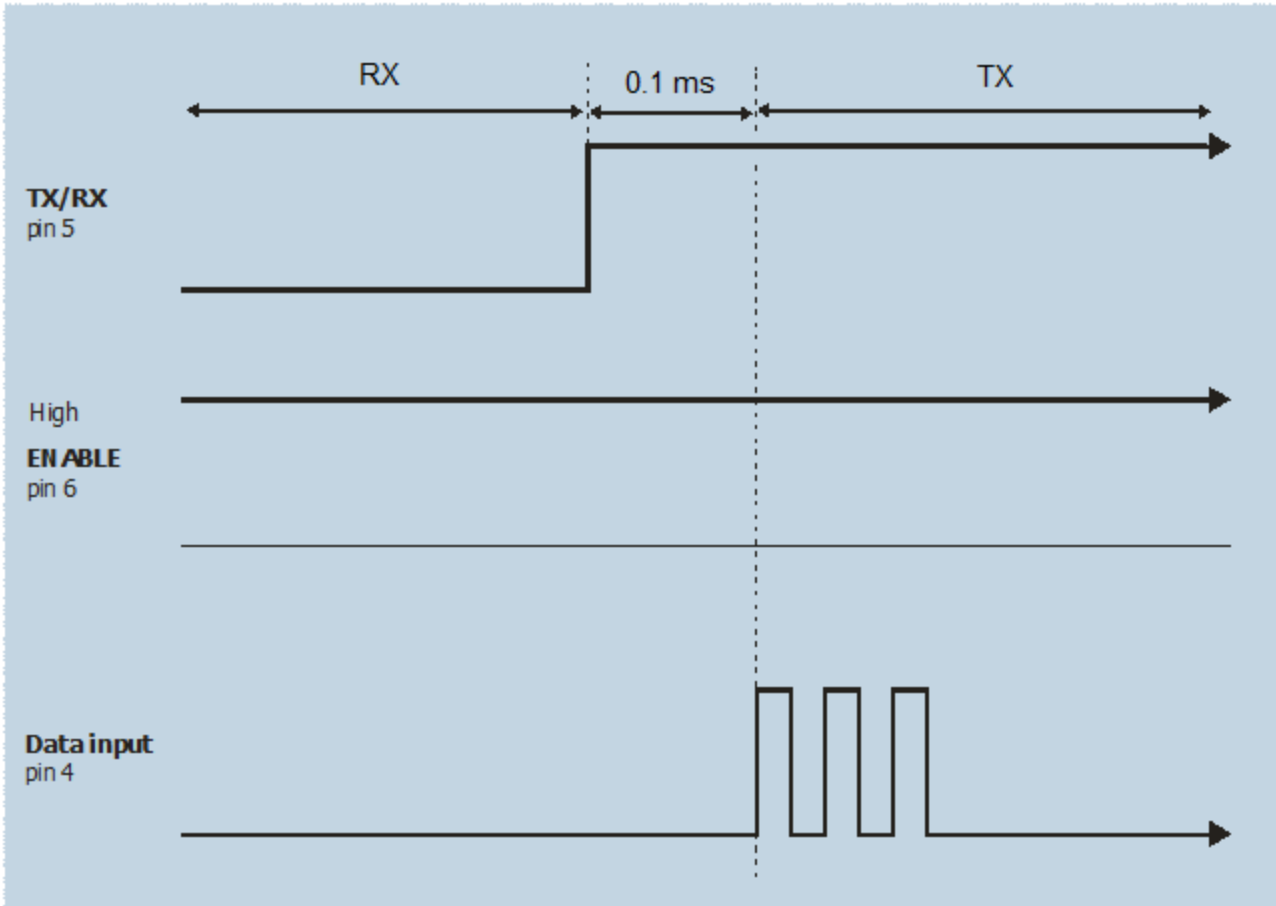

Figure 5

Le caratteristiche tecniche possono subire variazioni senza preavviso. AUR°EL S.p.A. non si assume la responsabilità di danni causati dall'uso improprio del dispositivo.

Time chart TX→RX

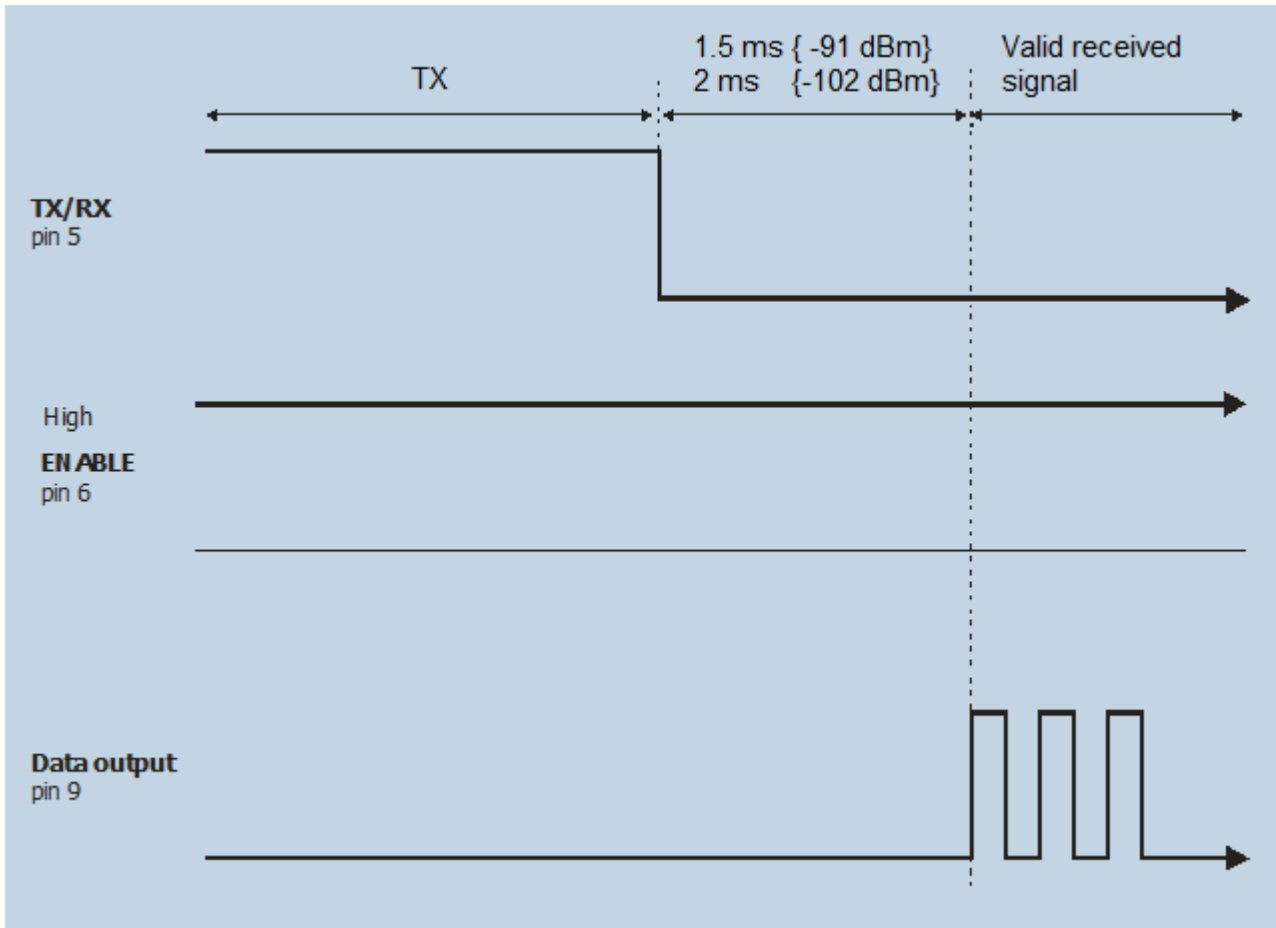

Figure 6

Le caratteristiche tecniche possono subire variazioni senza preavviso. AUR°EL S.p.A. non si assume la responsabilità di danni causati dall'uso improprio del dispositivo.

Device Usage

To take advantage of the performances detailed in the Technical Specifications, and in order to comply with the operating conditions which characterize the Certification, the transmitter must be fitted on a printed circuit considering the followings:

DC Supply

1. The transceiver must be supplied by a very low voltage source, safety protected against short circuits. Maximum voltage variations allowed: $2.5 \div 3.6V$.
2. De-coupling, next to the transmitter, by means of a minimum 100.000 pF ceramic capacitor.
3. Are preferable low noise linear voltage regulator circuits. Eventual voltage regulators DC-DC or AC-DC can introduce disturbances on radio modules.

Ground:

It must surround at the best the welding area of the module. The circuit must be double layer, with throughout vias to the ground planes. Strip must be 2,7 mm wide for 1,6 mm thick FR4 printed circuits and 1,6 mm wide for 1 mm thick FR4 printed circuits.

Antenna:

Typical aerial is a whip antenna 17cm long with min section 0,5 mmq vertically positioned over a widespread round plane. Other antenna position (bend, helical) work with unpredictable performance.

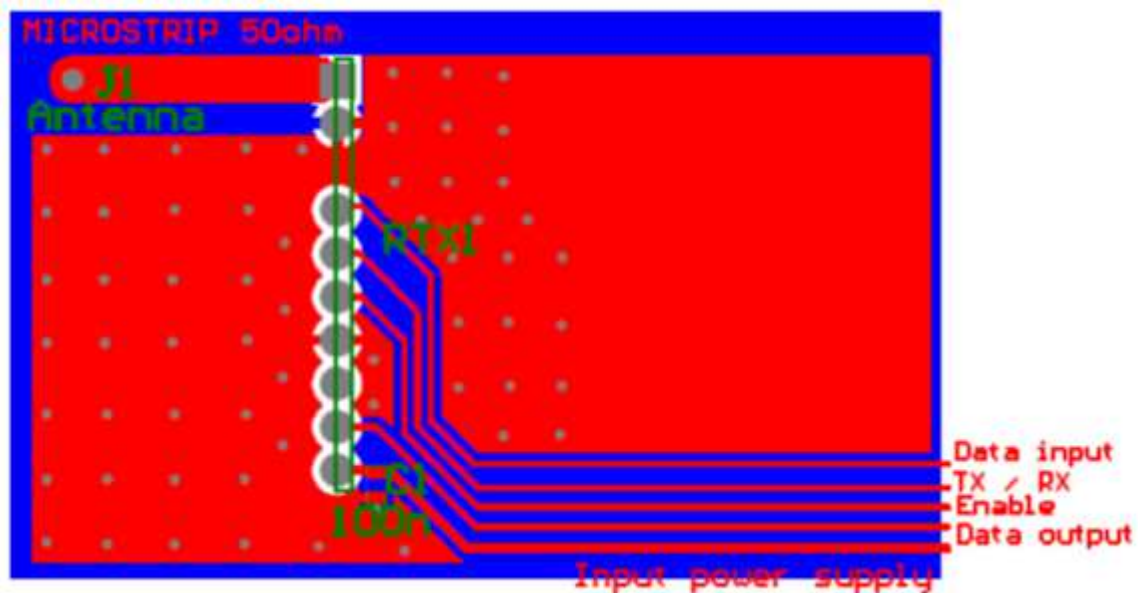

Figure 7

Other components:

1. Do not fit lines close to 50 ohm antenna connection.
2. Keep the transmitter separate from all other components of the circuit (more than 5 mm).
3. Keep particularly far away and shielded all microprocessors and their clock circuits.

Reference Rules

RTX-4M3V-FSK transceivers comply with European set of rules **EN 300 220**, and **EN 301 489**.
The transceiver must be supplied by a very low voltage safety source protected against short circuits. The equipment can be utilized inside a special insulated housing to ensure the compliance with the EN 60950.
The use of the transceiver module is foreseen inside housings that assure the overcoming of the provision **EN 61000-4-2** not directly applicable to the module itself. In particular, it is at the user' s care the insulation of the external antenna connection, and of the antenna itself since the RF output of the receiver is not built to directly bear the electrostatic charges foreseen by the above mentioned provision.

CEPT 70-03 Recommendation

RTX-4M3V-FSK transceivers work in the harmonized frequency band and therefore, in order to comply with rules in law, the maximum hourly duty cycle of the device must be the 10% (i.e. 6 minutes per hour).

The suggested antenna implementation ($\lambda/4$ whip antenna) guarantees to overpass the rules in terms of emitted power.

Power Supply Diagram

In Figure 8 it is displayed the diagram of current consumption in TX and RX mode versus voltage supply. In TX mode the current consumption has been measured driving high pin 4 (data in).

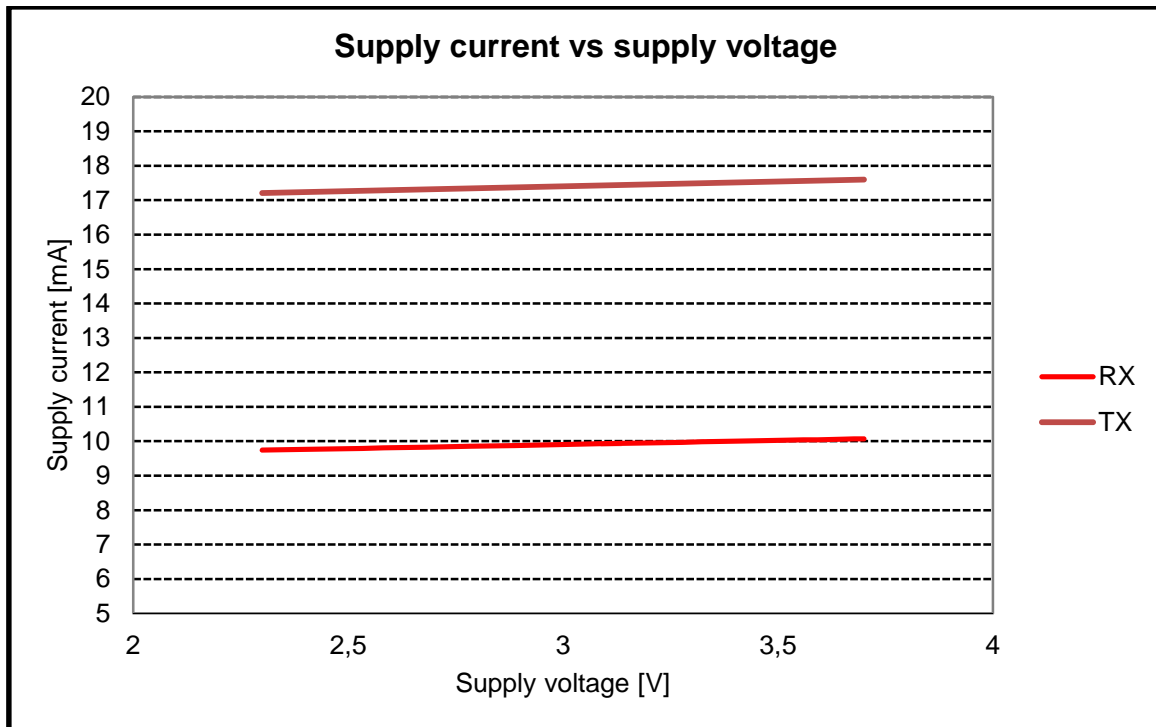

Figure 8

Thermal Diagrams

Thermal test has been conducted at 3V voltage supply.

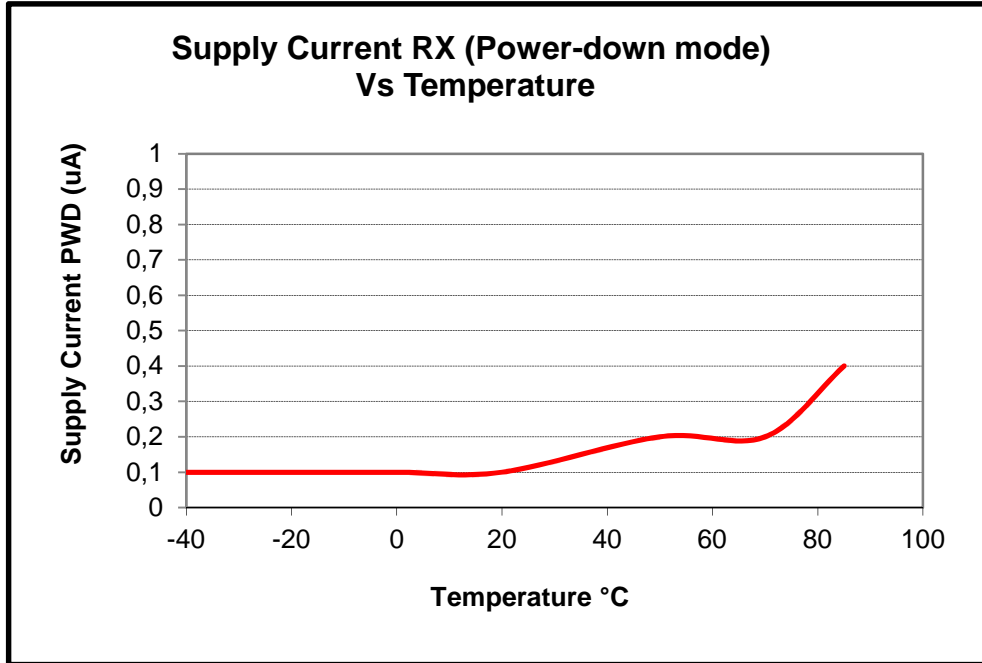

Figure 9

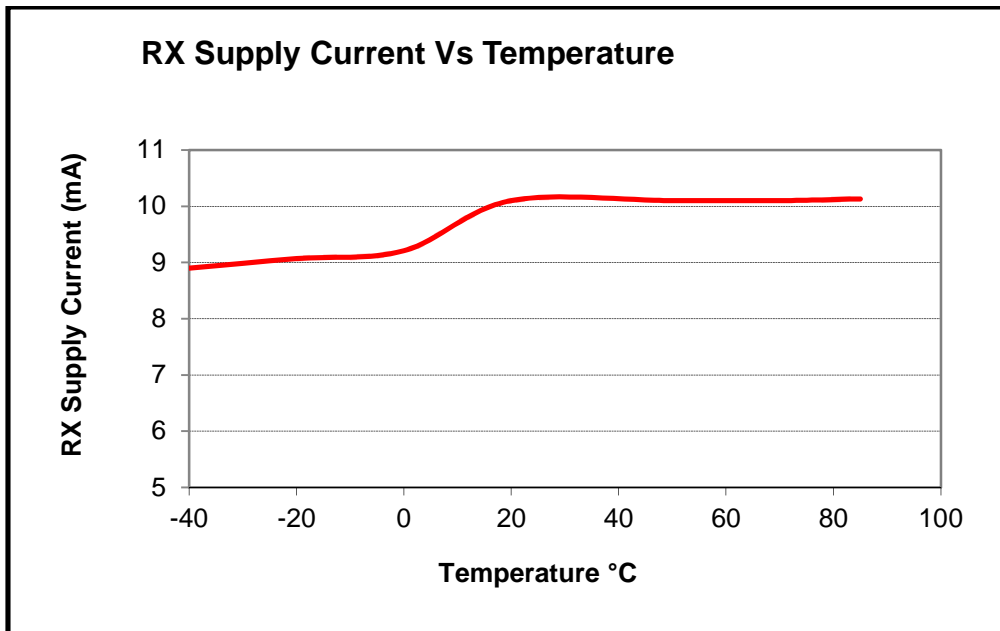

Figure 10

Le caratteristiche tecniche possono subire variazioni senza preavviso. AUR°EL S.p.A. non si assume la responsabilità di danni causati dall'uso improprio del dispositivo.

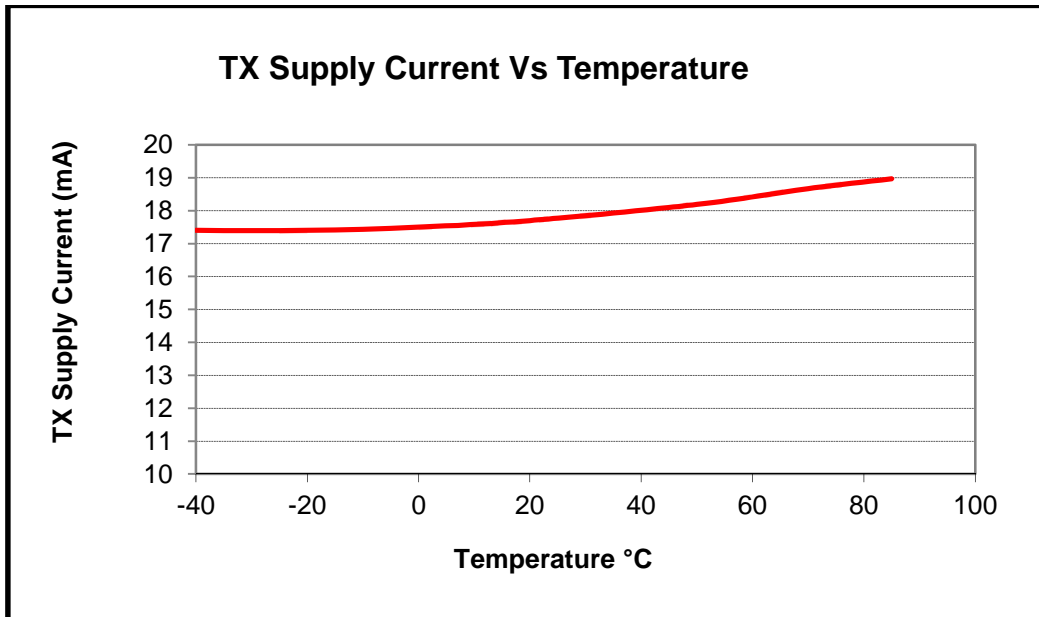

Figure 11

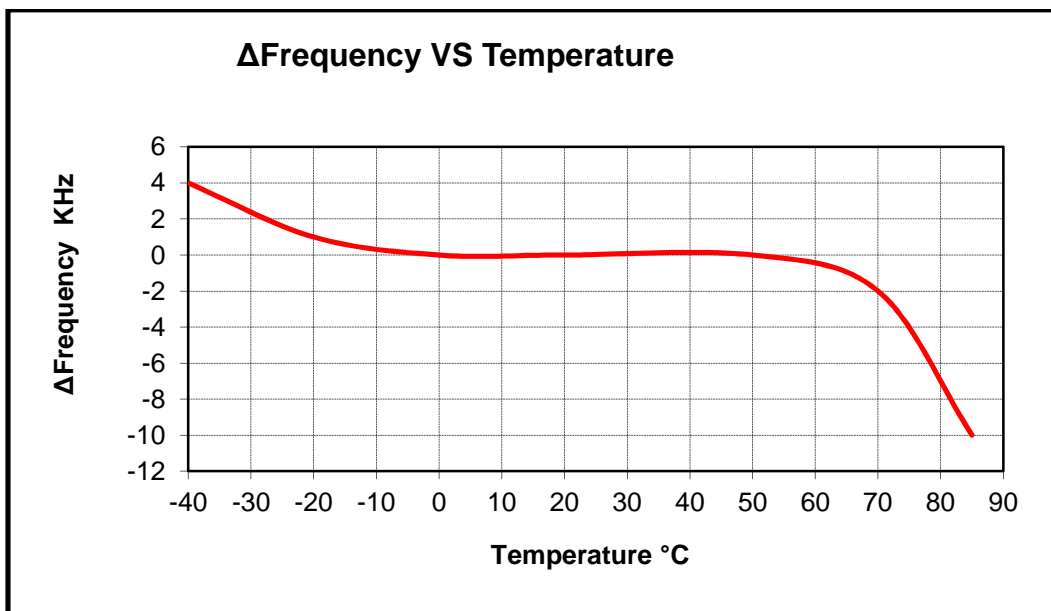

Figure 12

Le caratteristiche tecniche possono subire variazioni senza preavviso. AUR°EL S.p.A. non si assume la responsabilità di danni causati dall'uso improprio del dispositivo.

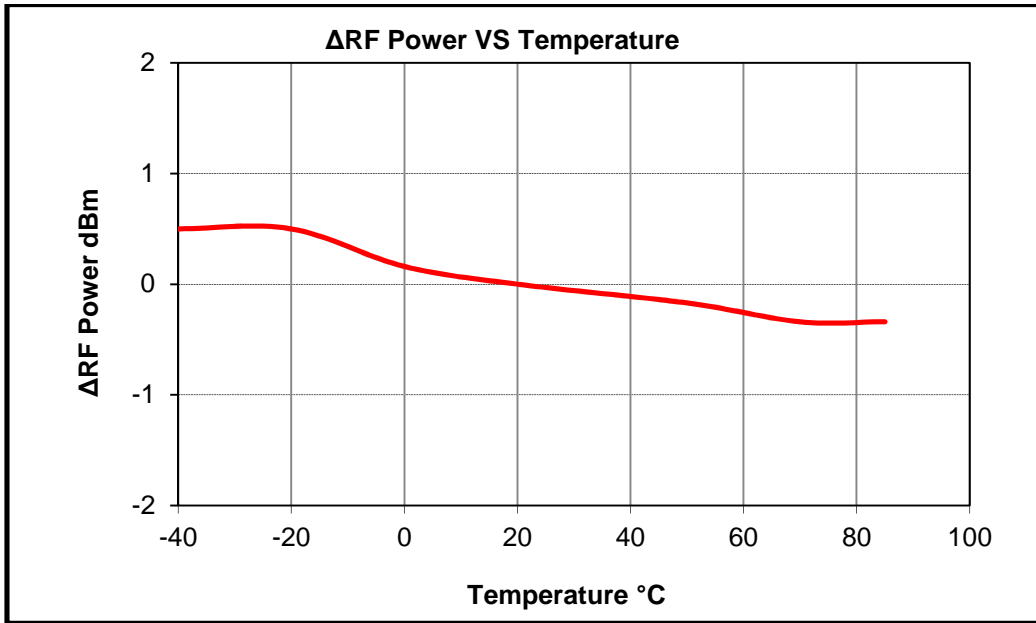

Figure 13

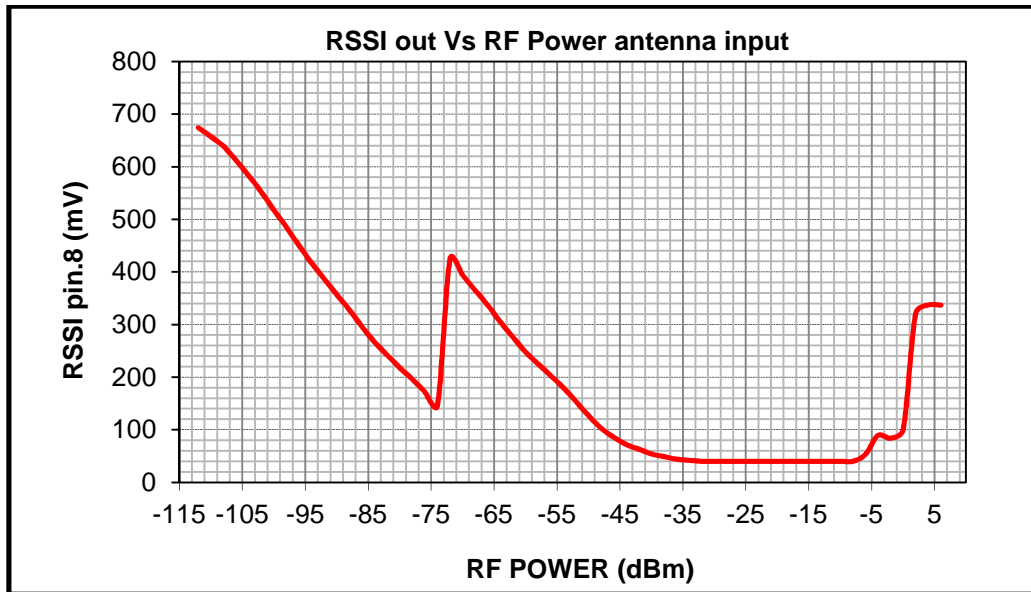

Figure 14

Le caratteristiche tecniche possono subire variazioni senza preavviso. AUR°EL S.p.A. non si assume la responsabilità di danni causati dall'uso improprio del dispositivo.