

RTX-MID-3V/RTX-MID-5V is an RF digital data transceiver working on the ISM free-license band of 433.92 MHz, in half-duplex way, ASK modulated and fast switch time TX→RX and RX→TX.

It's ideal for low cost solutions, battery supplied and thanks to its small size to hand held terminals.

Max speed rate is 10 Kbit/sec and it's compatible with RS232 standard @9600 bps (TTL levels), not requiring any balancing of data.

The device can work in compliance with HCS Microchip data frame.

All transceiver features can be handled by 4 lines (RX/TX, ENABLE, DATA IN, DATA OUT).

The module is available as 3V and 5V version and it's compliant to EN300 220 and EN300 489 rules.

Characteristics

- **Low current consumption**
- **Low cost**
- **PLL synthesis crystal based**
- **Single RF channel**
- **Very small size (25.4x12.43 mm)**
- **Max bit rate : 9600 bps**
- **Max Output Power : 10 mW**
- **High sensitivity on reception**
- **Voltage supply: 3V or 5V**

Applications

- **Wireless handsfree**
- **Home automation**
- **Wireless sensors**
- **Meter reading**
- **2-way remote controls**
- **Data logging**

Absolute maximum

Operational Temperature	-20 °C ÷ +85 °C
Stocking Temperature	-40 °C ÷ +100 °C
Voltage Supply	-0,3V +6V
Input Voltage	-0,3V÷VCC+0,3V
Output Voltage	-0,3V÷VCC+0,3V

Le caratteristiche tecniche possono subire variazioni senza preavviso. AUR°EL S.p.A. non si assume la responsabilità di danni causati dall'uso improprio del dispositivo.

Technical Characteristics

	Min.	Typ.	Max.	Unit
DC Levels				
Voltage supply Vcc (RTX-MID-3V)	2.1	3	3,6	V
Voltage supply Vcc (RTX-MID-5V)	4.5	5	5.5	V
Current (Rx mode) – Enable=1, TX/RX=0		6,4	8,5	mA
Current (Tx mode PA ON) Usage condition: Enable = 1 TX/RX = 1 Data in = 1		13	20	mA
Current (Tx mode PA OFF or idle mode) Usage condition: Enable = 1 TX/RX = 1 Data in = 0		4,5	6,5	mA
Current consumption (stand-by mode)	0,8	1,2	8	µA
Logic level "1" in input/output	0,9 X Vcc			V
Logic level "0" in input/output			0,1 X Vcc	V
Receiver				
Frequency		433,92		MHz
Modulation	ASK			
RX sensitivity (at 10Kbps) RF generator with 99% modulation		-106		dBm
IF frequency		10,7		MHz
Intermediate frequency band –3dB		280		KHz
RF band (SAW filtered)		600		KHz
Data rate			10	Kbps
Image frequency rejection		TBD		
Transmitter				
Transmission frequency		433,92		MHz
Modulation	ASK			
RF output power	8		12	dBm
Spurious emission <1GHz			-36	dBm
Spurious emission from 1GHz to 4GHz			-30	dBm
Data-rate			10	Kbps
Switching times				
PWRDN → RX		480		us
PWRDN → TX		420		us
TX → RX		260		us
RX → TX		400		us

Le caratteristiche tecniche possono subire variazioni senza preavviso. AUREL S.p.A. non si assume la responsabilità di danni causati dall'uso improprio del dispositivo.

Pin description and mechanical size

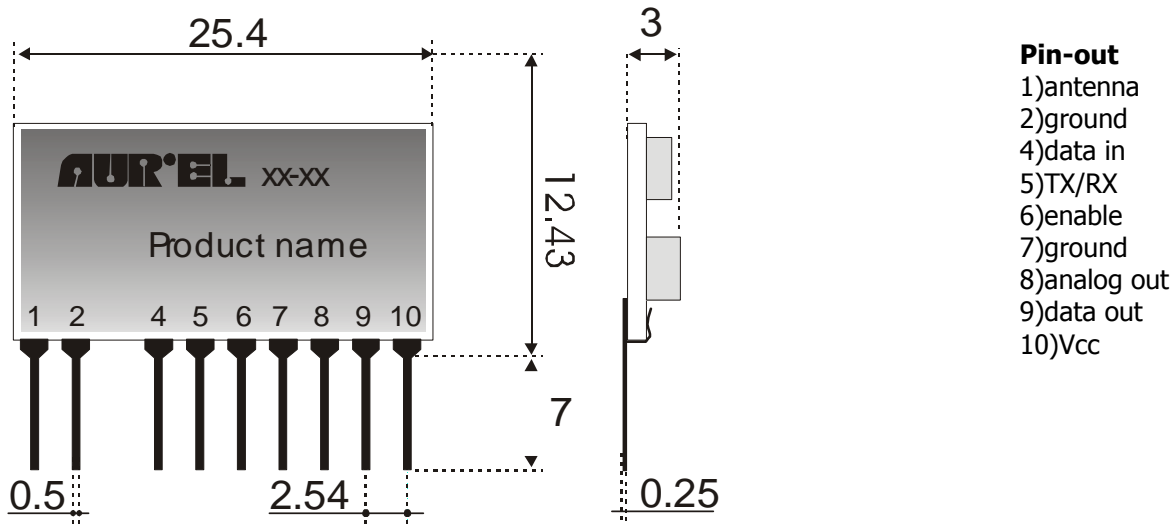

Tab. 1: pin description

n° Pin	Name	Description
1	Antenna	Antenna connection 50 ohm. RF output of TX, RF input of RX
2	GND	Ground
4	Data In	Data Input of TX 1 = emission of carrier 0 = no emission
5	TX/RX	0 or N.C = Receiver mode (Receiver ON, Transmitter OFF) 1 = Transmitter (Receiver OFF, Transmitter ON) NOTE: look at figure 2 for switching times Pin connected to pull down resistor
6	Enable	Connettere al positivo o negativo d'alimentazione come di seguito: 0 = PWDN (dispositivo spento con consumo tipico 1uA) 1 = Attivo (dispositivo acceso pronto a ricevere o trasmettere)
7	GND	Ground
8	Analog Out	Output analog for test purpose. Connect resistor network for squelch function. (See data-slicer description in the receiver section)
9	Data Out	Digital data output of receiver with 0-Vcc voltage range and 10 mA current. When in transmission (pin 5 high) data output is connected to pull down
10	Vcc	Connection to the suppli positive pole: 2,1-3,6Volts (RTX-MID-3V) 4,5-5Volts (RTX-MID-5V) Connect 100 nF capacitor towards ground plane

Le caratteristiche tecniche possono subire variazioni senza preavviso. AUREL S.p.A. non si assume la responsabilità di danni causati dall'uso improprio del dispositivo.

Block diagram

Block Diagram

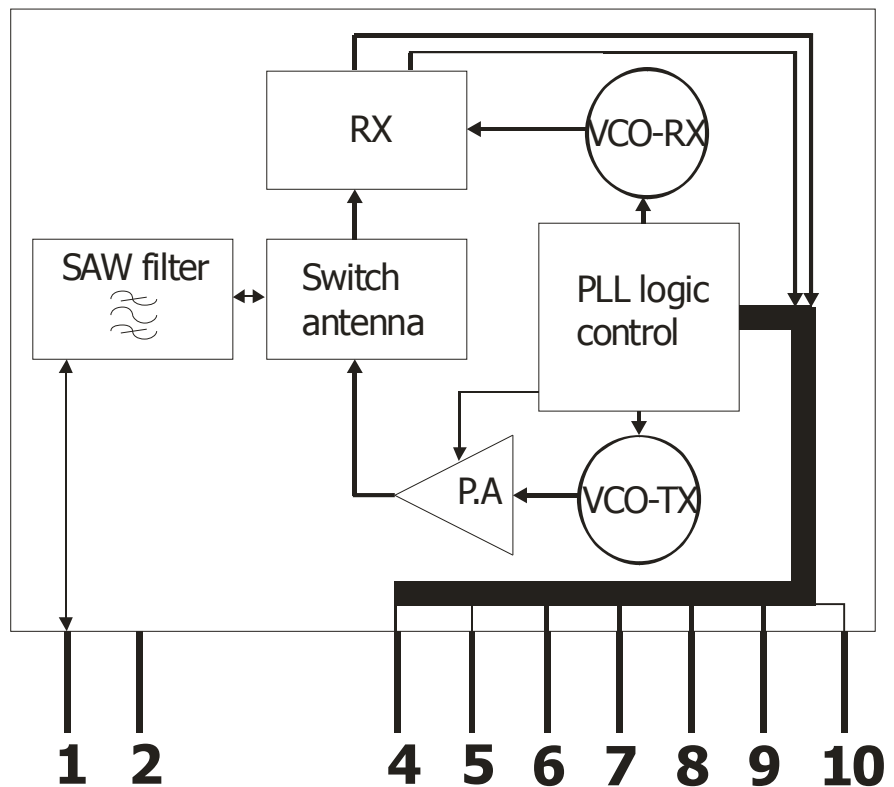

Transmitter

It embeds a VCO oscillator controlled by PLL circuit in order to achieve short switching time TX-RX and wake up time from stand-by mode.

A power amplifier boosts the emitted power up to 12 dBm.

Spurious emissions are limited by SAW filter technology.

Transmitter is switched on driving high RX/TX line and low the data in line.

The PLL circuit switches on in 200-300 uS, necessary time to set properly the RF oscillator.

In order to transmit, drive high or low the data in line according to the desired data sequence.

Data can be an encoded frame or just coming from UART port of microcontroller and data rate must be lower than 10 kbit/sec.

Receiver

It's a single conversion superhet receiver with local oscillator, mixer circuit with frequency image rejection and IF frequency at 10.7 MHz

Front end circuit and AGC:

A SAW filter is in the middle between antenna and pre-amplifier stage in high gain cascode configuration. AGC (automatic gain control) circuit acting on the gain improves the dynamic of RF received signal.

AGC turns on whenever the the RF received signal is more powerful than -55 dBm and it sets the max gain 7ms after the RF signal goes down the -59 dBm.

This tolerance range prevents endless switches of AGC during reception.

Data-Slicer:

This circuit converts the analog signal coming from L.F. to digital one.

It's made up of a comparator, a min/max peak detector circuit of LF analog signal, connected to RC network with fast charge and discharge (time constant equals to 22 ms).

The circuit allows reception of data pulses with length lower than 5 ms and higher than 100 us.

It's possible to receive UART RS-232 signals, as the byte contains at least a high or low level, allowing the peak detector to operate properly. It's not possible to transmit a DC low or high level for a time longer than 5 ms; therefore in case of transmission of proprietary data frame, it is recommended to encode data taking care of the pulse length limit (5ms).

Squelch immunity to data output:

The digital output of receiver (pin 9) hasn't any immunity to white noise generated by the receiver itself when no carrier is on air, then pseudo-random code, like white noise, comes out of the data output.

Typically digital output is connected to the input port of a microcontroller which must recognise valid data among the white noise.

It's possible to drive low the data output in absence of RF signal just by supplying around 1.5V to the analog output (pin 8). See fig.1 which shows a diagram.

Drawback of such configuration is a 3B reduction of receiver sensitivity and a slight distortion of duty-cycle.

This configuration can be adopted if the best performance of transceiver is not required. Highest immunity to noise means a reduction of receiver sensitivity.

The above considerations are valid for both RTX-MID-3V and RTX-MID-5V.

3. RF Transmission Mode

From Idle Mode the device turns to Transmission Mode when data in line (pin 4) is driver high. When logic level high is present on data in input the RF carrier is emitted through antenna with 10 mW power and the overall consumption is around 16 mA.

4. RF Receiver Mode

Reception mode is selected by driving low pin 5 (RX/TX) and high pin 6 (ENABLE).

There are two way to do it:

1) From powerdown mode (pin 4-5-6 low), drive high pin 6 (ENABLE), then after 20us drive high pin 5 (RX/TX) 200us, hold on 40us and then drive down 20us pin 6 (ENABLE).

After 200 us the device is ready for reception.

2) From Transmission Mode to Receiver Mode follow the procedure:

Drive down pin 5 (RX/TX), after 40us drive down pin 6 (ENABLE) 20us long.

After 200 us the device is ready for reception.

This procedure is necessary to get the lowest charge and discharge time of of RC time constants in the receiver stage.

If not respected this procedure, the switching on time of receiver becomes longer up to 20-30 ms.

Switching PWRDN→RX, PWRDN→TX, RX→TX, TX→RX.

In order to respect latency time of PLL circuit and peak detectors in data-slicer stage, it is mandatory to keep the timing in the following pictures, in switching from TX to RX, from RX to TX and from power down to RX or TX.

Time chart PWRDN→RX

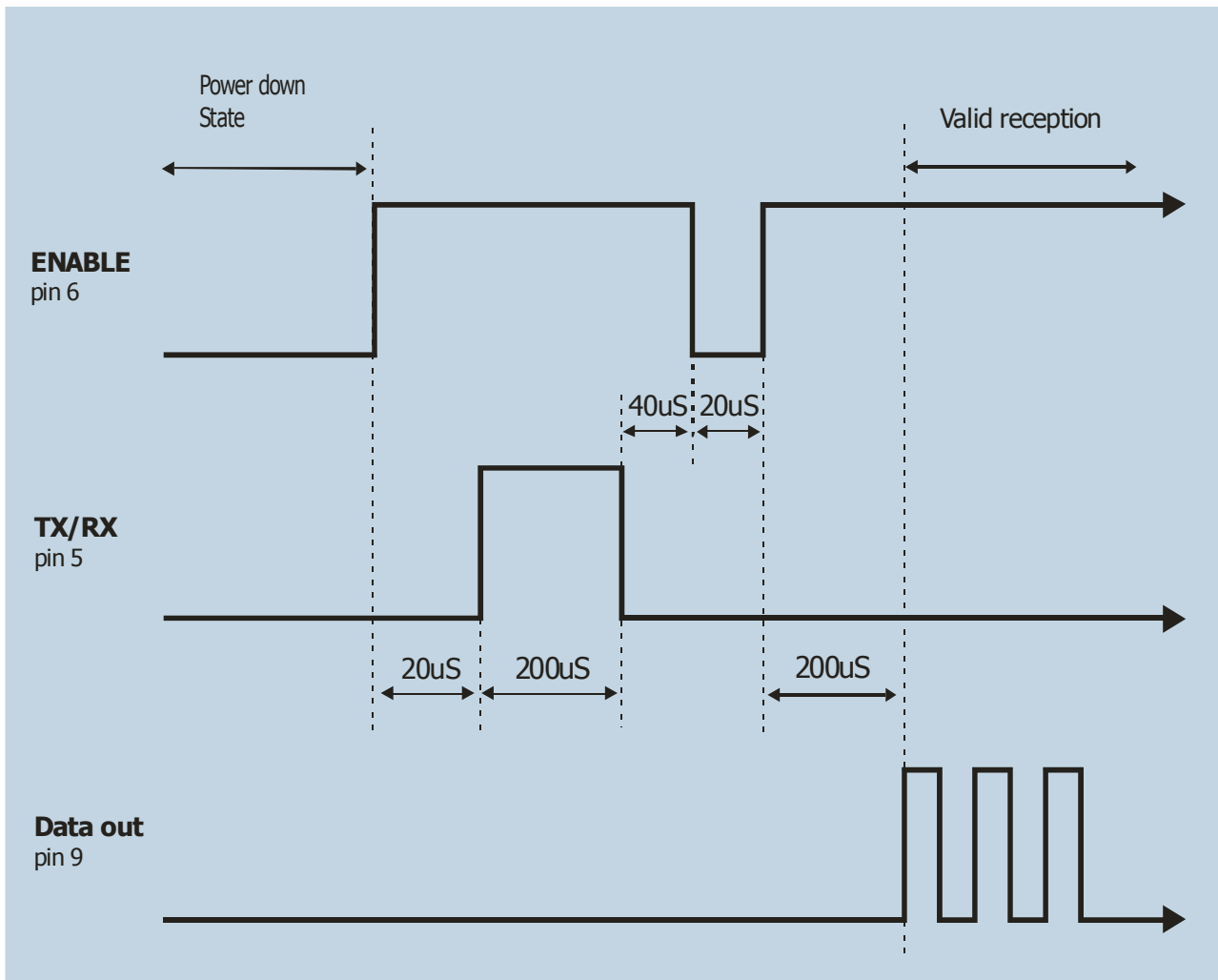

The above sequence of pin ENABLE and TX/RX assures the shortest charge and discharge time of peak detectors

Time chart PWRDN → TX

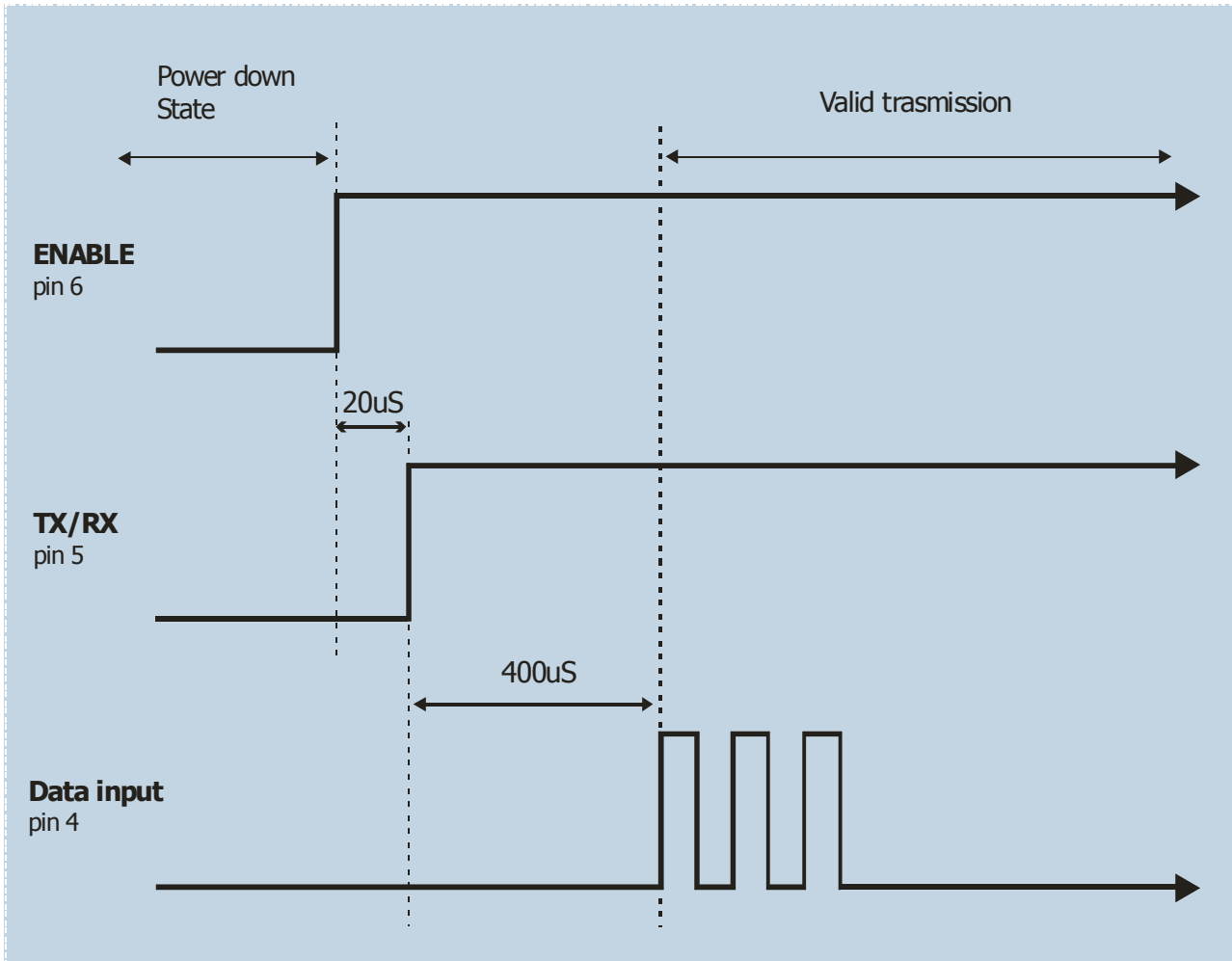

Le caratteristiche tecniche possono subire variazioni senza preavviso. AUR°EL S.p.A. non si assume la responsabilità di danni causati dall'uso improprio del dispositivo.

Time chart RX → TX

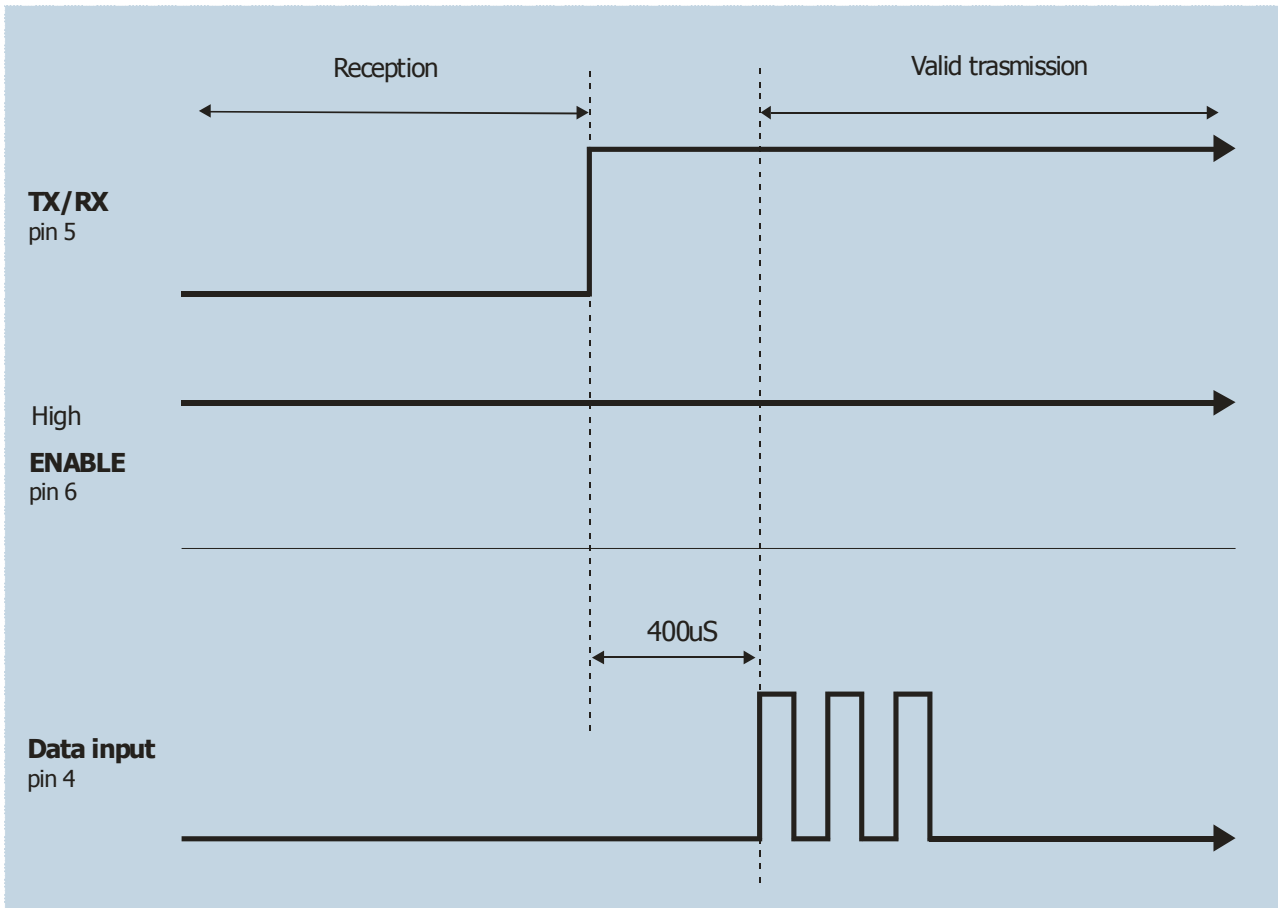

Le caratteristiche tecniche possono subire variazioni senza preavviso. AUR^oEL S.p.A. non si assume la responsabilità di danni causati dall'uso improprio del dispositivo.

Time chart TX→RX

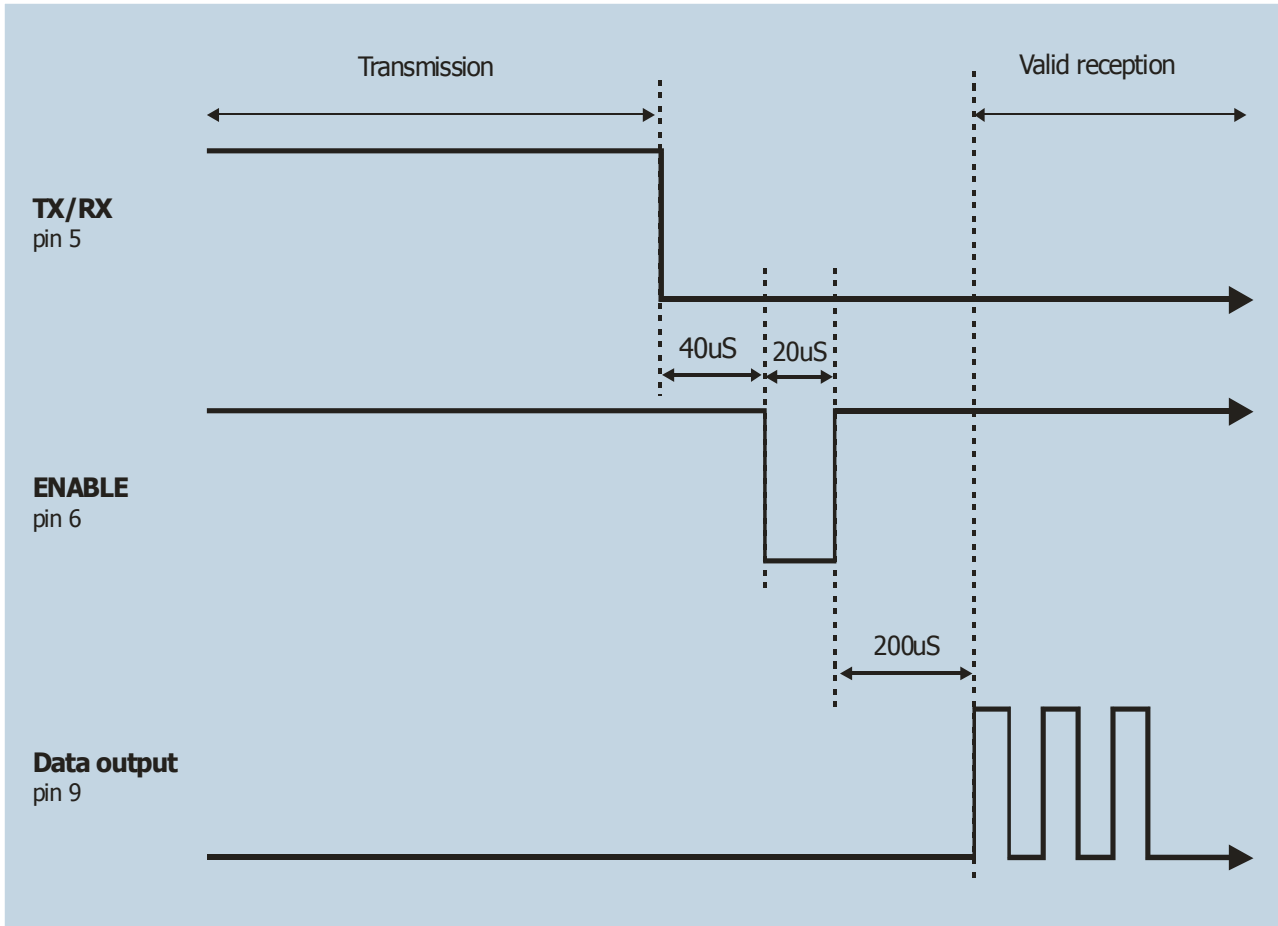

Le caratteristiche tecniche possono subire variazioni senza preavviso. AUR[°]EL S.p.A. non si assume la responsabilità di danni causati dall'uso improprio del dispositivo.

CASES STUDY

REPEAT OF ENCODED DATA LIKE KEYFOB

RTX-MID transceiver can be used in "always on" mode to act as a relay station of encoded commands, allowing an extension of radio link.

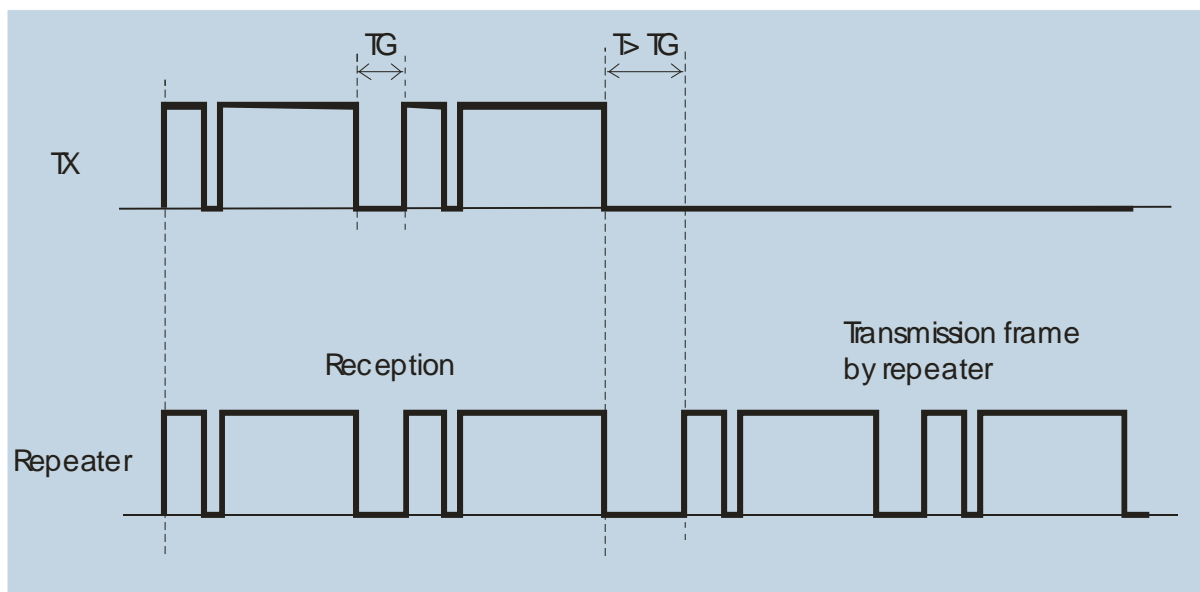
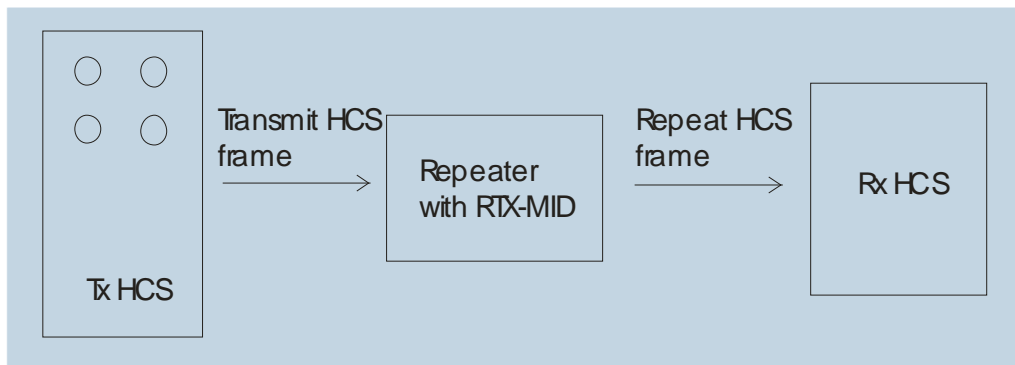

Repeater is usually on reception when time T is longer than guard time TG (no more frames received), repeater switches to TX and repeat the received frame N times. In this case the consequence of pushing the button occurs when the button itself is released.

Le caratteristiche tecniche possono subire variazioni senza preavviso. AUR^oEL S.p.A. non si assume la responsabilità di danni causati dall'uso improprio del dispositivo.

DATA TRANSMISSION (EX THERMOSTAT) AND ACKNOWLEDGEMENT

RTX-MID transceiver can be used to forward the temperature value to the heater and to get back an acknowledgement from heater itself.

This permits a 2-way radio link between thermostat and heater.

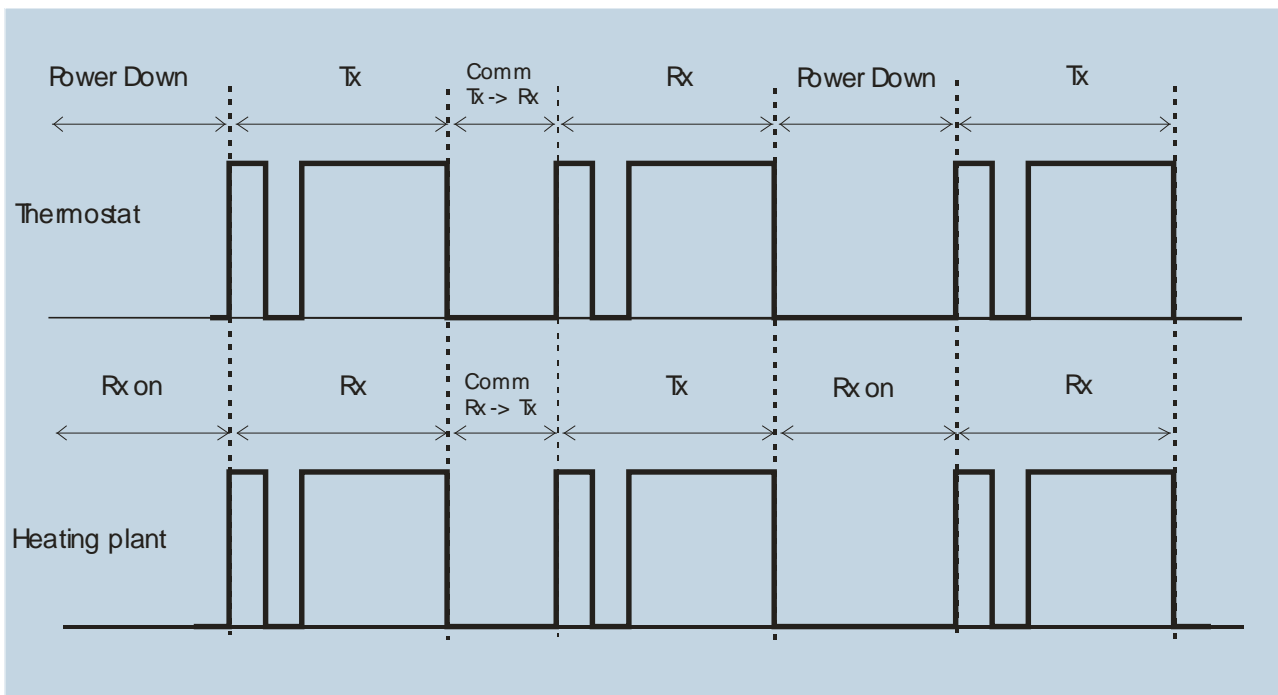
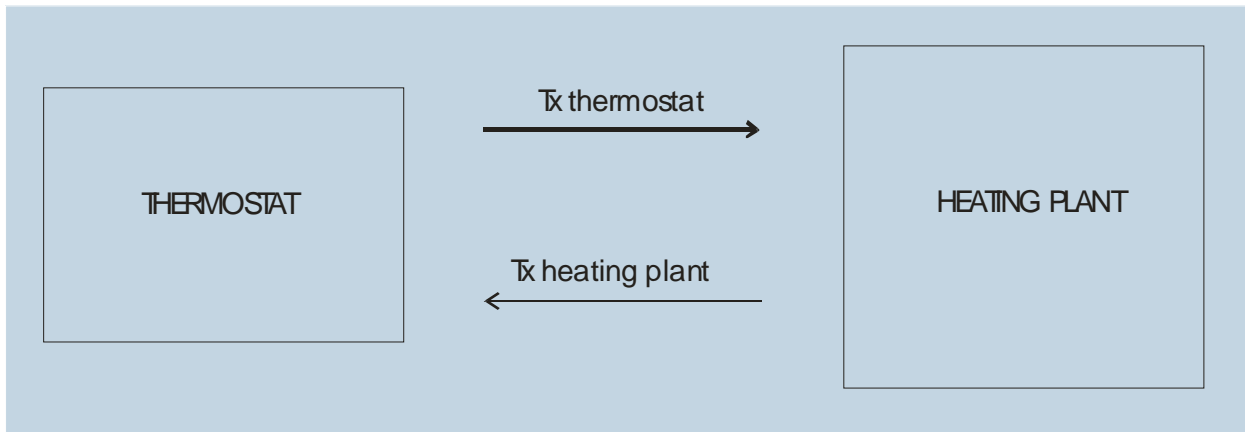

The frame time shows a possible solution, where the thermostat keeps on in power-down mode and wakes up every 100 sec, transmits 2 frames (around 250 msec both) embedding the temperature value and id code, switches to reception and waits for a reply. If it doesn't get any reply, it turns to power-down mode otherwise it gets data from heater within 250 ms. The overall turn on time is then 500 ms max. Estimating 10 mA as current consumption both in RX and TX mode, transmitting every 100 s the average current consumption is around 50 uA, permitting a long battery life even for cells with limited capacity.

Le caratteristiche tecniche possono subire variazioni senza preavviso. AUR^oEL S.p.A. non si assume la responsabilità di danni causati dall'uso improprio del dispositivo.

Device Usage

To take advantage of the performances detailed in the Technical Specifications, and in order to comply with the operating conditions which characterize the Certification, the transmitter must be fitted on a printed circuit considering the followings:

DC Supply:

1. The transceiver must be supplied by a very low voltage source, safety protected against short circuits. Maximum voltage variations allowed: 2,1÷3,6V (RTX-MID-3V) and 4,5÷5,5V (RTX-MID-5V).
2. De-coupling, next to the transmitter, by means of a minimum 100.000 pF ceramic capacitor.

Ground:

It must surround at the best the welding area of the module. The circuit must be double layer, with throughout vias to the ground planes. Strip must be 2,7 mm wide for 1,6 mm thick FR4 printed circuits and 1,6 mm wide for 1 mm thick FR4 printed circuits.

Antenna:

Typical aerial is a whip antenna 17cm long with min section 0,5 mmq vertically positioned over a widespread round plane. Other antenna position (bend, helical) work with unpredictable performance.

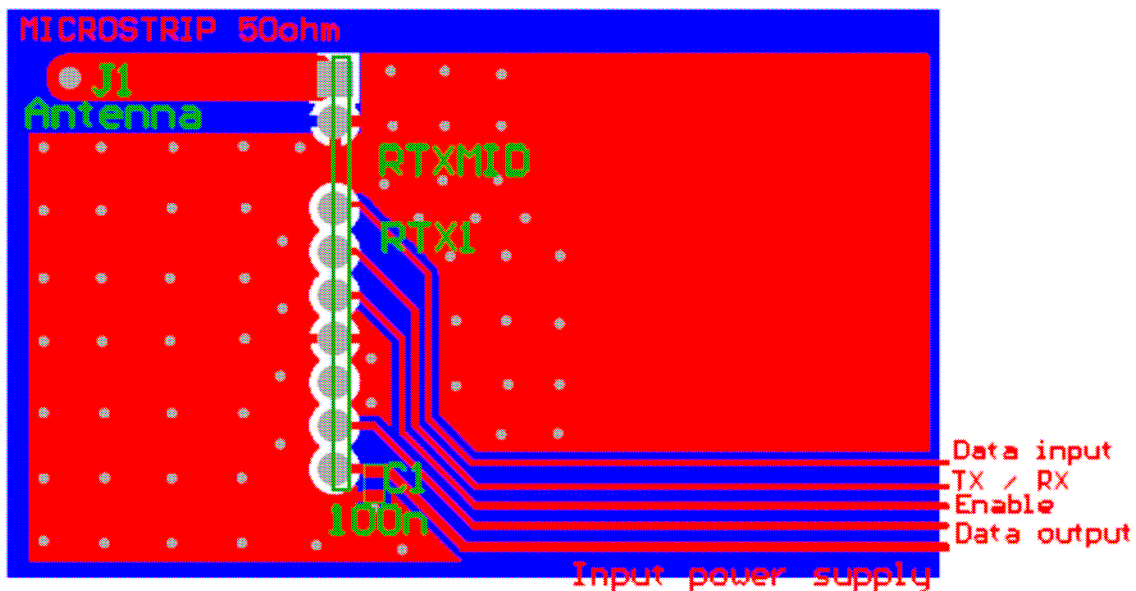

Fig 2

Other components:

1. Do not fit lines close to 50 ohm antenna connection.
2. Keep the transmitter separate from all other components of the circuit (more than 5 mm).
3. Keep particularly far away and shielded all microprocessors and their clock circuits.

Reference Rules

RTX-MID-3V and RTX-MID-5V transceivers comply with European set of rules **EN 300 220** in class 1, and **EN 301 489** in class 1.

The equipment has been tested according to rule **EN 60950** and it can be utilized inside a special insulated housing that assures the compliance with the above mentioned rule. The transceiver must be supplied by a very low voltage safety source protected against short circuits.

The use of the transceiver module is foreseen inside housings that assure the overcoming of the provision **EN 61000-4-2** not directly applicable to the module itself. In particular, it is at the user's care the insulation of the external antenna connection, and of the antenna itself since the RF output of the receiver is not built to directly bear the electrostatic charges foreseen by the a.m. provision.

CEPT 70-03 Recommendation

RTX-MID-3V and RTX-MID-5V transceivers work in the harmonized frequency band and therefore, in order to comply with rules in law, the maximum hourly duty cycle of the device must be the 10% (i.e. 6 minutes per hour).

The suggested antenna implementation ($\lambda/4$ whip antenna) guarantees to overpass the rules in terms of emitted power.

Diagrams (RTX-MID-3V)

In fig. 1 it is displayed the diagram of current consumption in TX and RX mode versus voltage supply. In TX mode the current consumption has been measured driving high pin 4 (data in).

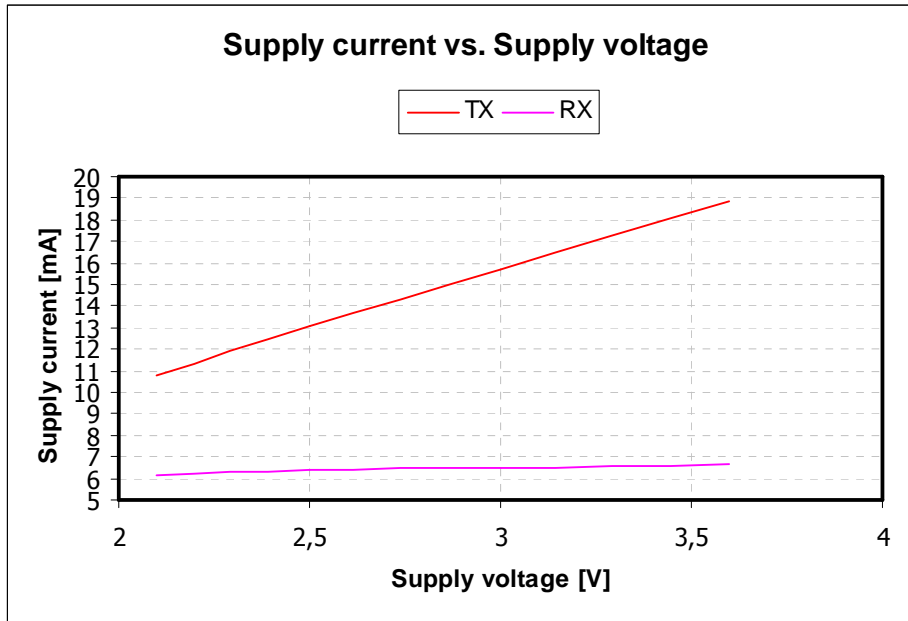

Fig.1 Current consumption in TX and RX mode vs voltage supply.

In fig 2 it's displayed the RF output power versus voltage supply.

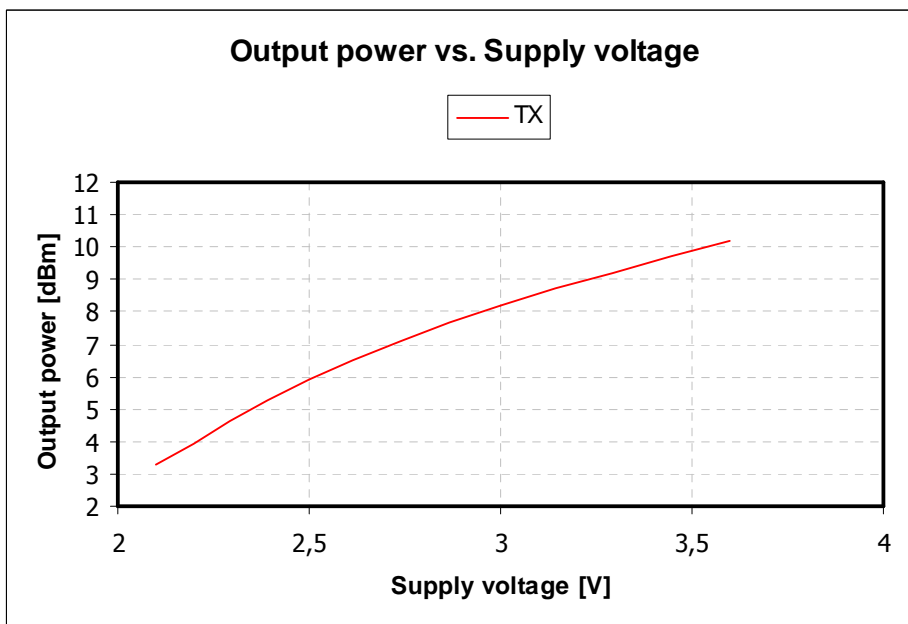

Fig.2 RF output power vs voltage supply

Le caratteristiche tecniche possono subire variazioni senza preavviso. AUR^oEL S.p.A. non si assume la responsabilità di danni causati dall'uso improprio del dispositivo.

Thermal Diagrams

Thermal test has been conducted at 3V voltage supply.

In fig 3 it's displayed how current consumption in TX and RX mode changes, compared to 20°C nominal temperature, over an extended temperature range.

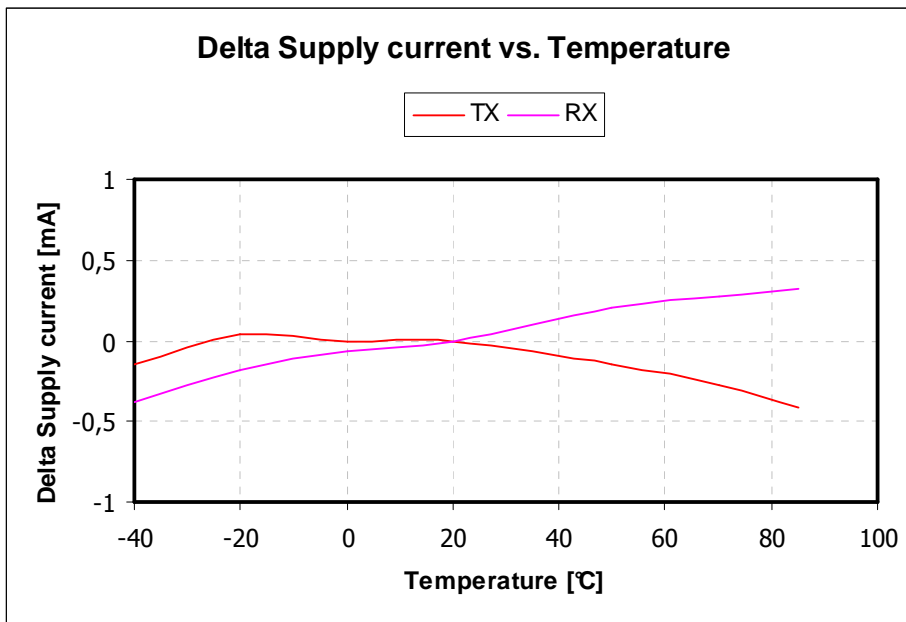

Fig.3 Delta Current consumption in TX and RX mode versus temperature.

In fig 4 it's displayed how RF output power changes over an extended temperature range. Measure has been conducted keeping high pin 4 (data in).

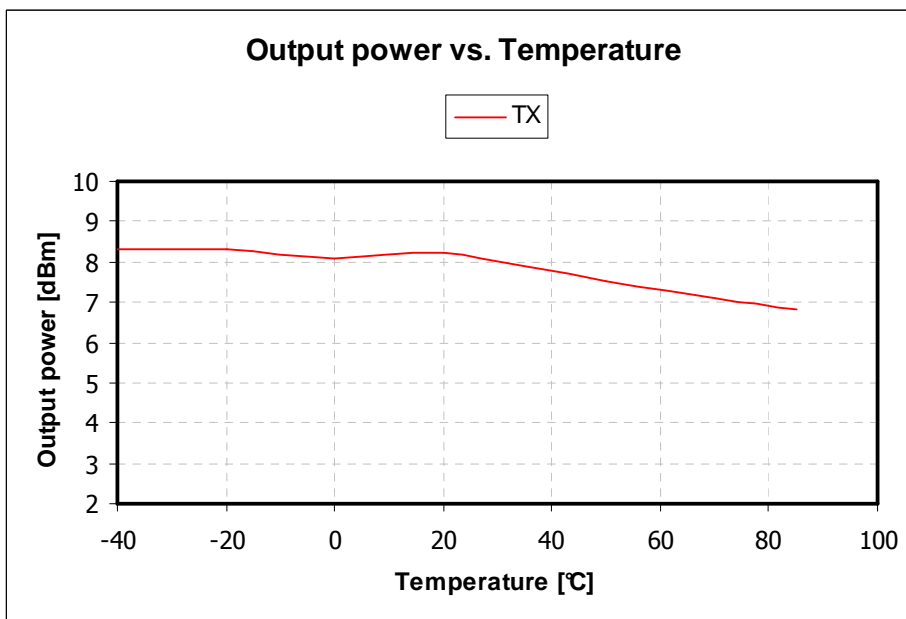

Fig.4 RF output power vs temperature

Le caratteristiche tecniche possono subire variazioni senza preavviso. AUR^oEL S.p.A. non si assume la responsabilità di danni causati dall'uso improprio del dispositivo.

In fig 5 it's displayed the frequency drift, compared to nominal value measured at 20°C, versus temperature.

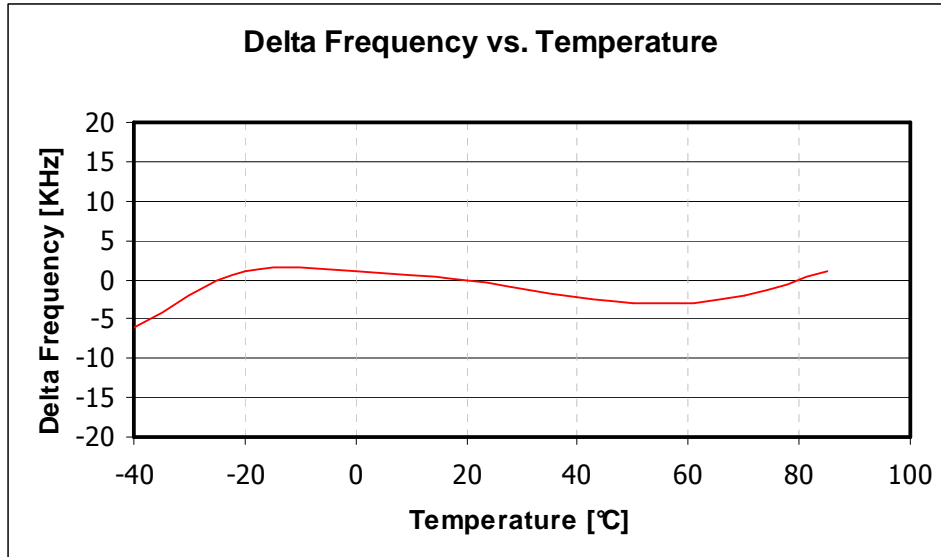

Fig.5 Frequency drift vs temperature

In fig 6 it's displayed the sensitivity versus temperature.

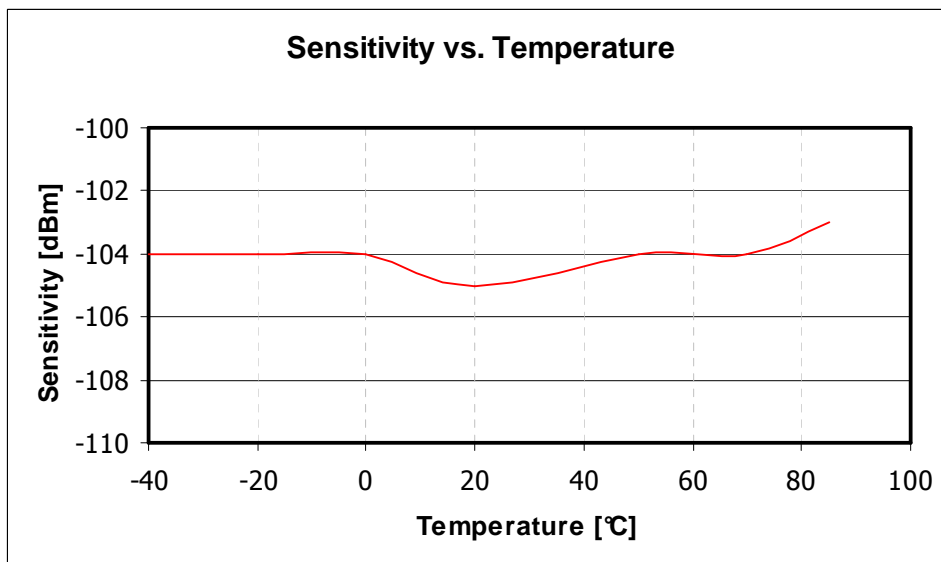

Fig.6 Sensitivity vs temperature

Le caratteristiche tecniche possono subire variazioni senza preavviso. AUR[°]EL S.p.A. non si assume la responsabilità di danni causati dall'uso improprio del dispositivo.

Diagrams (RTX-MID-5V)

In fig. 1 it is displayed the diagram of current consumption in TX and RX mode versus voltage supply. In TX mode the current consumption has been measured driving high pin 4 (data in).

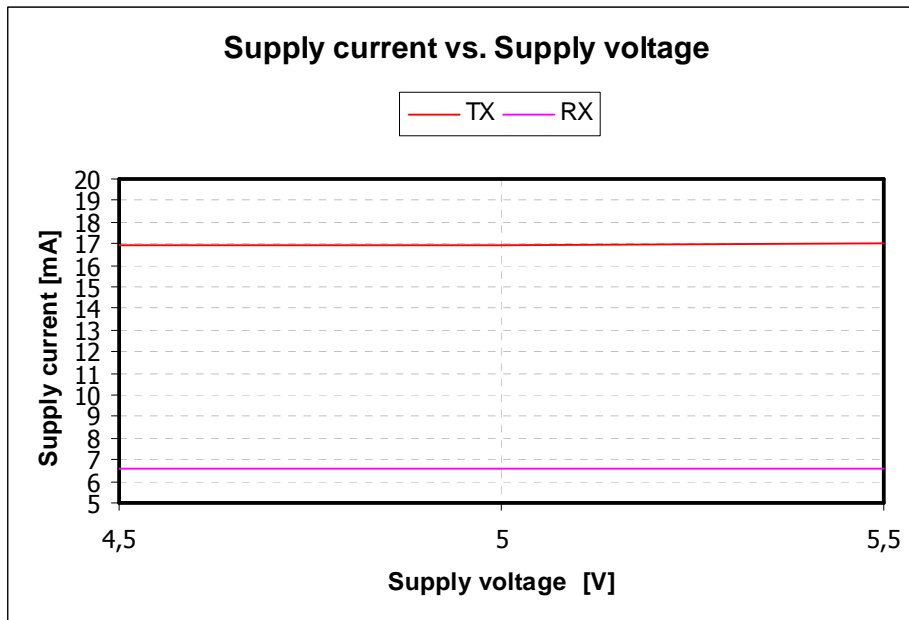

Fig.1 Current consumption in TX and RX mode vs voltage supply.

In fig 2 it's displayed the RF output power versus voltage supply.

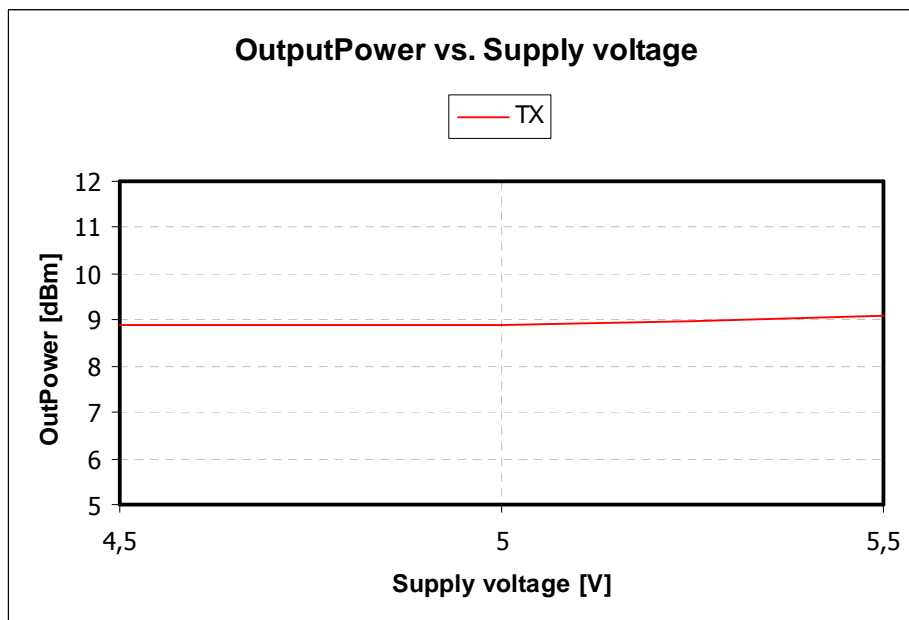

Fig.2 RF output power vs voltage supply

Le caratteristiche tecniche possono subire variazioni senza preavviso. AUR°EL S.p.A. non si assume la responsabilità di danni causati dall'uso improprio del dispositivo.

Thermal Diagrams

Thermal test has been conducted at 5V voltage supply.

In fig 3 it's displayed how current consumption in TX and RX mode changes, compared to 20°C nominal temperature, over an extended temperature range.

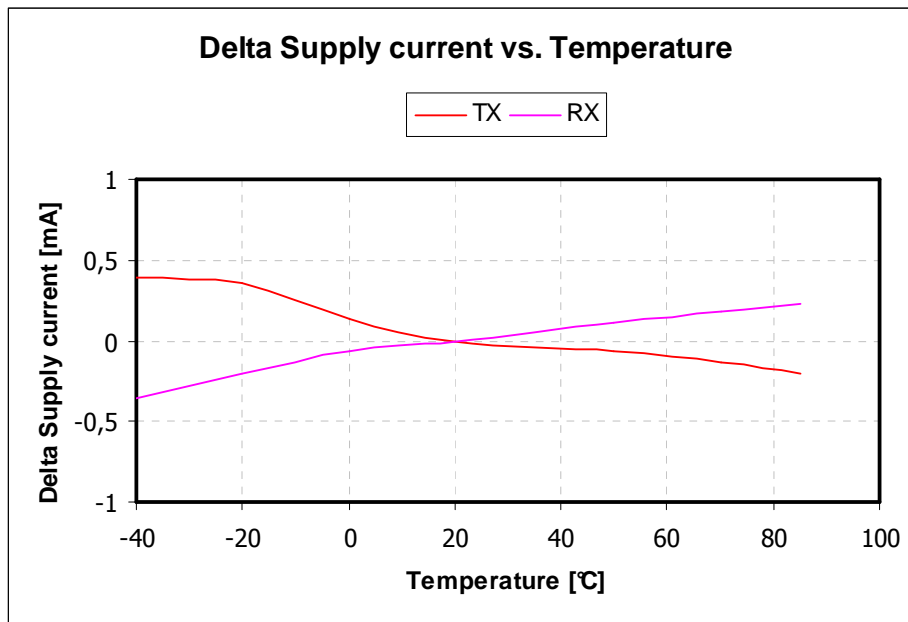

Fig.3 Delta Current consumption in TX and RX mode versus temperature.

In fig 4 it's displayed how RF output power changes over an extended temperature range. Measure has been conducted keeping high pin 4 (data in).

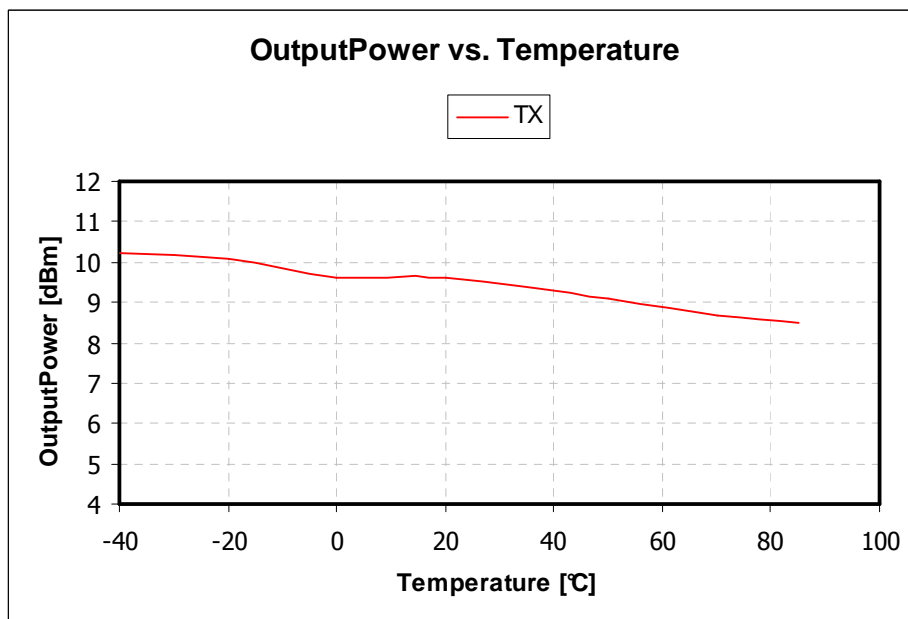

Fig.4 RF outup power vs temperature

Le caratteristiche tecniche possono subire variazioni senza preavviso. AUR[°]EL S.p.A. non si assume la responsabilità di danni causati dall'uso improprio del dispositivo.

In fig 5 it's displayed the frequency drift, compared to nominal value measured at 20°C, versus temperature.

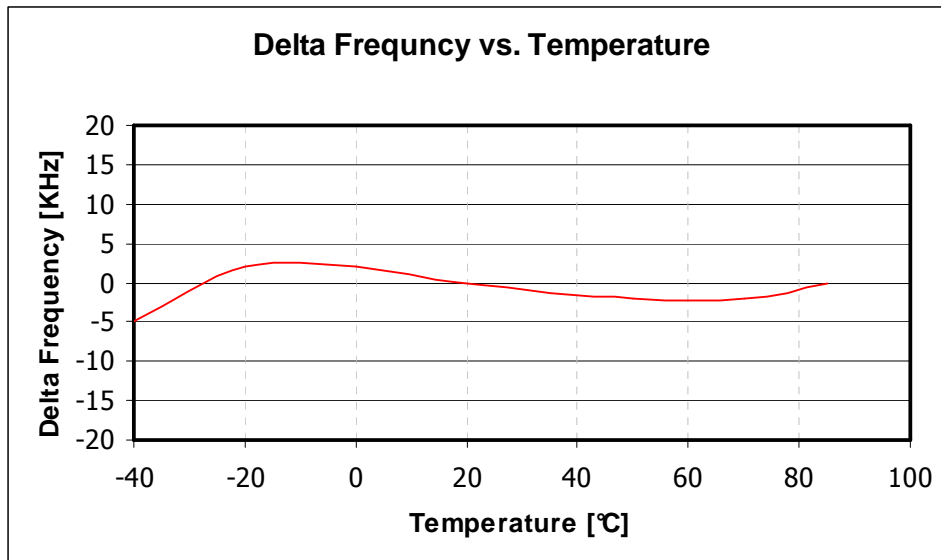

Fig.5 Frequency drift vs temperature

In fig 6 it's displayed the sensitivity versus temperature.

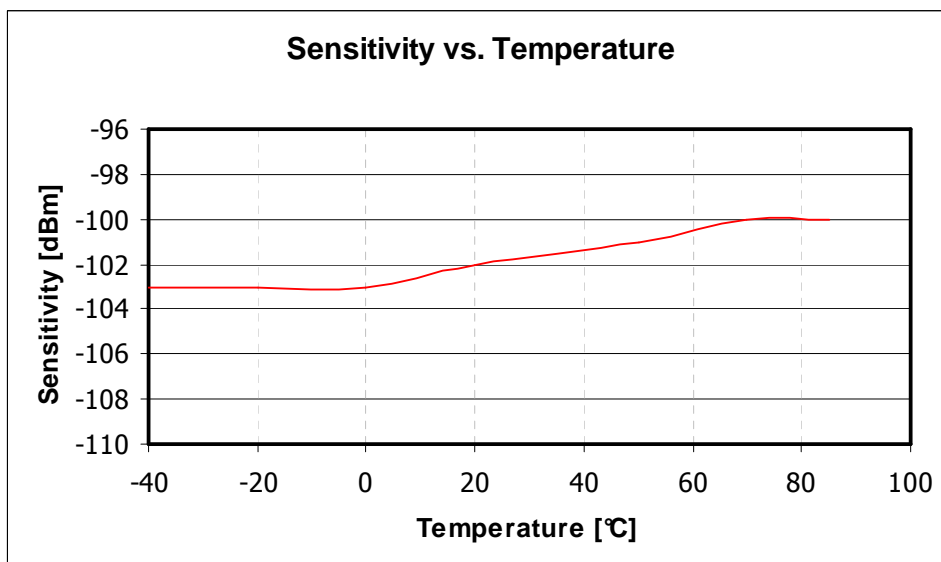

Fig.6 Sensitivity vs temperature

Le caratteristiche tecniche possono subire variazioni senza preavviso. AUR°EL S.p.A. non si assume la responsabilità di danni causati dall'uso improprio del dispositivo.